

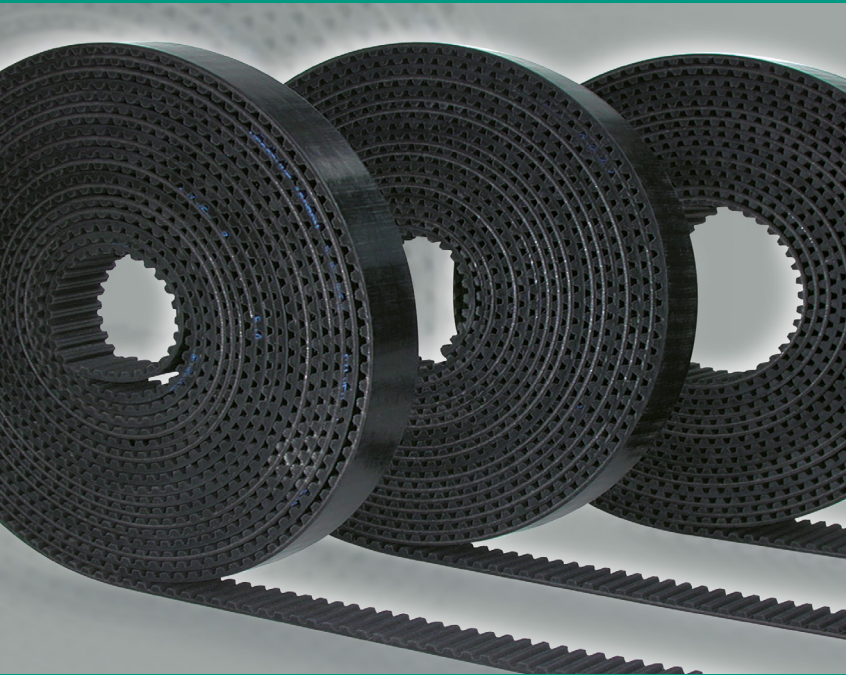

**MEGADYNE**



# ***RUBBER OPEN ENDED***

TECHNICAL  
HANDBOOK

*EN*

# INDEX

Introduction to rubber open-ended belts	<b>2</b>
Classifications	<b>3</b>
Technical calculation	<b>5</b>
Calculation example	<b>8</b>
Calculation parameters	<b>10</b>
Belt installation and feasibility table	<b>11</b>
Belt failures	<b>13</b>
Belt data	
MXL	<b>14</b>
XL	<b>16</b>
L	<b>18</b>
H	<b>20</b>
RPP3	<b>22</b>
RPP5	<b>24</b>
RPP8	<b>26</b>
RPP8 steel cords	<b>28</b>
RPP14 steel cords	<b>30</b>
SILVER3 3M	<b>32</b>
SILVER3 5M	<b>34</b>
SILVER3 8M	<b>36</b>
TITANIUM 8M	<b>38</b>
TITANIUM 14M	<b>40</b>
STD8	<b>42</b>
Special execution feasibility	<b>44</b>
Clamping plates	<b>45</b>
Useful formulas and conversion table	<b>46</b>
Data sheet	<b>47</b>



# INTRODUCTION TO

## RUBBER OPEN-ENDED BELTS

Megadyne rubber open-ended belts are rubber based timing belts manufactured with high quality materials and state of the art production process. As a result of this Megadyne offers belts which have been designed to respond to the high demands of today's industrial market.

Megadyne rubber open-ended belts are specially suitable for reversing drives and applications when rotational movements need to be transformed into linear motion and high positioning accuracy is required.

Megadyne rubber open-ended belts are a great solution when substituting expensive conventional linear systems. Noise level improvement will be obtained as well as economic benefits due to the reduction of the initial investment and the maintenance costs.

Taking into account the advantages and the available product range, these belts can be considered as a solution for a very wide field of applications in industrial equipment. Few examples of typical applications can be:

- Automatic doors for garage
- Automatic sliding doors
- X-Y tables on tooling machines
- Level control on elevators
- Fitness machines
- Printers
- Linear positioning systems

## STANDARD RANGE

MXL • XL • L • H

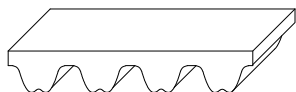

RPP3 • RPP5 • RPP8 • RPP14 • SILVER3 3M • SILVER3 5M • SILVER3 8M  
• TITANIUM 8M • TITANIUM 14M  
(SILVER3 14M • GOLD2 5M • GOLD2 8M • GOLD2 14M on demand)

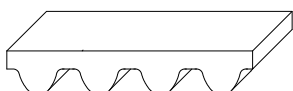

STD8



RUBBER OPEN-ENDED

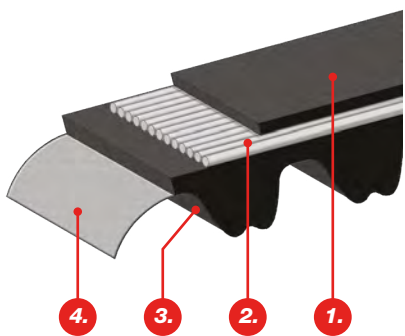

# CLASSIFICATIONS

## CLASSIFICATIONS

Megadyne rubber open-ended belts are manufactured in rubber compound. They come from sleeves for spiral cut belts and from press for straight cut belts.

The belt is made by:

### 1. BELT BACK

The back side cushion protects the tensile member and permits the use of backside idlers thanks to its elasticity.

### 2. TENSION MEMBERS

Fiberglass, steel or carbon cords of the latest technology grant the longitudinal rigidity and resistance of the belt.

### 3. BELT BODY

The belt body is made of special polychloroprene-based, nitrile-based, HNBR or EPDM rubber compound. These compounds guarantee the highest tooth shear resistance.

### 4. FABRIC

Hard wearing nylon fabric is bonded on tooth surface to improve torque carrying capacity. In addition a special coating gives self-lubricating action and increases drive efficiency.

## BELT CONSTRUCTION

The advantages of Megadyne rubber open-ended belts are:

- High positioning accuracy on reverse drives.
- To cover a wide range of applications.
- Low noise level due to vibration absorbing characteristic of rubber.
- Low operation costs due to free of maintenance and long lasting service life.
- Compact and light drives are feasible due to high specific belt performance.

## MECHANICAL AND CHEMICAL CHARACTERISTICS

- Constant dimensions
- Noiseless
- Maintenance-free
- High flexibility with fiberglass cords
- Linear speed up to 50 m/s
- Low pretension
- Constant length
- High abrasion resistance
- Standard working temperature -25 /+80 °C;  
for TITANIUM: -40/+120°C  
for SLV3 and GLD2: -25/+100°C



# CLASSIFICATIONS

## BODY

Megadyne rubber open-ended belts are manufactured with polychloroprene compound. Special compounds (different hardness, special properties) are available on request. See below for compound characteristics:

RESISTANCE TO	STANDARD BELT RESISTANCE
Mineral oils	LOW
Water	MEDIUM
Acids / Alkalis	NONE
Solvents	NONE
Oils	LOW
Greases	MEDIUM
Fuels	NONE
Environment agents	MEDIUM

TEMPERATURE	
Min T (°C)	-25; -40 (TITANIUM)
Max T (°C)	80; +120 (TITANIUM); +100 (SLV3, GLD2)
Max peak T (°C)	100; +140 (TITANIUM)

## IDENTIFICATION CODE

Using the information in the table below, it is possible to identify the correct belt for every application.

The code is composed of letters and numbers as the following example:

1		2
H	+	200
RPP5	+	15
SILVER3 8M	+	25

- 1.** This code composed by letters and numbers indicates the selection of tooth pitch and tooth profile.
- 2.** This number indicates the width of the requested belts. The value is in mm for belts with metric pitch and in inches for belts with imperial pitch.



# TECHNICAL CALCULATION

## LINEAR MOTION BELT

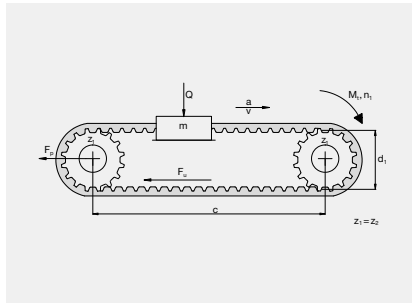

## OMEGA LINEAR MOTION BELT

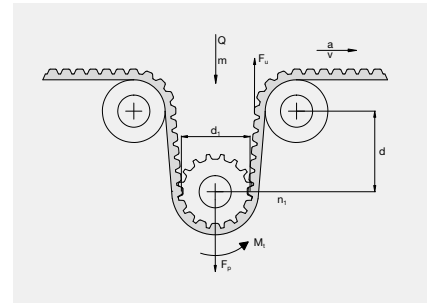

The following pages contain data, formulae and tables that are required to design a new belt drive.

For critical and difficult drives, it is recommended that you contact our Application Department for advice.

SYMBOL	UNIT	DEFINITION
<b>b</b>	mm	belt width
<b>L</b>	mm	belt length
<b>c</b>	mm	centre distance
<b>d<sub>i</sub></b>	mm	pitch diameter of pulley i
<b>m</b>	kg	total conveyed mass
<b>a</b>	m/s <sup>2</sup>	acceleration
<b>v</b>	<b>m/s</b>	<b>belt speed</b>
<b>C<sub>s</sub></b>	-	safety factor
<b>g</b>	m/s <sup>2</sup>	gravity (9.81)
<b>μ</b>	-	coefficient of friction <sup>(1)</sup>
<b>p</b>	-	belt pitch
<b>MTL</b>	N	Max Traction Load
<b>F<sub>p</sub></b>	N	pretension
<b>F<sub>u</sub></b>	N	peripheral force
<b>F<sub>p spec</sub></b>	N/cm	transmittable force per tooth per unit
<b>M<sub>t</sub></b>	Nm	drive torque
<b>n<sub>1</sub></b>	1/min	revs/min (RPM)
<b>P</b>	kW	drive power
<b>Q</b>	N	force exerted by mass (m)
<b>z<sub>1</sub></b>		number of teeth on pulley i
<b>z<sub>m</sub></b>		number of teeth in mesh on driver pulley
<b>z<sub>s</sub></b>		number of teeth on small pulley
<b>z<sub>L</sub></b>		number of teeth on largest pulley
<b>BS</b>	N	Breaking Strength

*Max Traction Load is maximum acceptable traction on cords*

*Breaking Strength is necessary load to break belt cord*

<sup>(1)</sup> Between the belt and the guide

## USEFUL FORMULAE AND CONVERSION FACTORS

$$\begin{aligned}
 V &= \frac{d_1 \cdot n_1}{19100} & n_1 &= \frac{V \cdot 19100}{d_1} & d_1 &= \frac{V \cdot 19100}{n_1} & Q &= m \cdot g \\
 P &= \frac{M_t \cdot n_1}{9550} & M_t &= \frac{9550 \cdot P}{n_1} & M_t &= \frac{F_u \cdot d_1}{2000}
 \end{aligned}$$

RUBBER OPEN-ENDED



# TECHNICAL CALCULATION

## CALCULATION OF THE PERIPHERAL FORCE ON THE TIMING BELT

<b>Knowing mass</b>	For horizontal & conveying drives	$F_u = (m \cdot a) + (m \cdot g \cdot \mu)$
	For vertical drives	$F_u = (m \cdot a) + (m \cdot g)$
<b>Knowing drive torque</b>	-	$F_u = 2000 M_t / d_1$
<b>Knowing drive power</b>	-	$F_u = 19.1 \cdot 10^6 \cdot P / (d_1 \cdot n_1)$

## BELT WIDTH AND PROFILE ESTIMATION

With the result of  $F_u$  select the belt type profile and approximate the belt width according to DIAGRAM 1 page 10 on "Belt width selection".

## CHOICE OF PULLEYS

Choose the closest standard pulley according to the data sheet of each belt type

$$z = \frac{\pi \cdot d_1}{p}$$

$$n_1 = \frac{6000 \cdot v}{p \cdot z_1}$$

Always verify that the chosen  $z$  is higher or equal to  $z_{min}$  written in belt data pages.

## DETERMINATION OF BELT WIDTH

The belt width  $b$  should be calculated using the following formula

$$b = \frac{F_u \cdot F_s \cdot 10}{F_{p, spec} \cdot z_m}$$

where:

- $F_u$  from above calculation.
- $F_s$  is the service factor from page 10.
- $F_{p, spec}$  is the transmittable force per tooth per cm, from belt data pages.
- $z_m$  is the number of teeth in mesh on driver pulley, that you can calculate as per below:

$$z_m = \left\{ 0,5 - \left[ \frac{4 p}{79 c} \cdot (z_1 - z_s) \right] \right\} \cdot z_s$$

This value  $z_m$  can't be higher than 12.

From the calculated width  $b$ , choose the next higher available width; you can check available widths in belt data page.



# TECHNICAL CALCULATION

## PRE-TENSIONING

The suggested installation tension is  $F_p = F_u \cdot 2$

## MESHING CHECK

In order to guarantee the correct function of the drive check the safety factor against break as per below:

$$\sigma_{BS} = \frac{BS}{F_u + \frac{F_p}{2}}$$

where:

- BS is the Breaking Strength (see tables on belt data pages)
- $F_u$  from above calculation
- $F_p$  is the tension, from above calculation

The  $\sigma_{BS}$  outcoming value has to be higher than 11 for fiberglass and 8 for steel cords. If it is lower, please retry with the next wider belts till you will get a value higher than 11 or 8.

## ELONGATION

You can find belt elongation from Belt Elongation diagrams in belt data pages at Load equal to  $F_p/2$  using the formula:

$$\Delta_{100} = \frac{\text{Belt's Max Elongation} \cdot F_p/2}{BS}$$



# CALCULATION EXAMPLE

## CALCULATION EXAMPLE

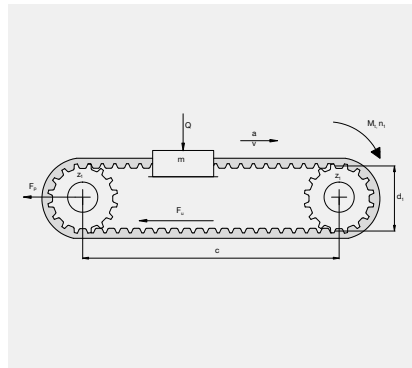

Type of application	<b>Automatic door</b>
Type of load	<b>Low fluctuation load</b>
Hours of daily service	<b>12 hours</b>
Desired pulley pitch diameter	<b><math>d_1 = 38,2 \text{ mm}</math></b>
Centre distance	<b><math>c = 3 \text{ m}</math></b>
Mass to carry	<b><math>m = 100 \text{ kg}</math></b>
Coefficient of friction	<b><math>\mu = 0,3</math></b>
Speed	<b><math>v = 1,5 \text{ m/s}</math></b>
Acceleration	<b><math>a = 1,5 \text{ m/s}^2</math></b>
Deceleration	<b><math>a_b = 1,5 \text{ m/s}^2</math></b>

### CALCULATION OF THE PERIPHERAL FORCE ON THE TIMING BELT

Since the mass is known,  $F_u$  can be calculated:

$$F_u = m \cdot a + m \cdot g \cdot \mu = 100 \cdot 1,5 + 100 \cdot 9,8 \cdot 0,3 = 444 \text{ N}$$

### BELT WIDTH AND PROFILE ESTIMATION

With the result of  $F_u$  select the belt type profile and approximate the belt width according to DIAGRAM 1 page 10 on "Belt width selection". The first estimation is for a RPP5M15.

### CHOICE OF PULLEYS

Knowing the pitch diameter

$$z_1 = \frac{\pi \cdot d_1}{p} = \frac{\pi \cdot 38,2}{5} = 24 > 14$$

where 14 is  $z_{\min}$  as per belt data page.

Always verify that the chosen  $z$  is higher or equal to  $z_{\min}$  written in belt data pages.

Knowing the linear speed

$$n_1 = \frac{6000 \cdot v}{p \cdot z_1} = \frac{6000 \cdot 1,5}{5 \cdot 24} = 750 \text{ rpm}$$

### DETERMINATION OF BELT WIDTH

To calculate the belt width  $b$  we need to find out the service factor  $F_s$  first:

$$F_s = \frac{F_1 + F_3 + F_4}{F_2} = \frac{1,4 + 0 + 0}{1} = 1,4$$



# CALCULATION EXAMPLE

where:

- F1, from table page 10, according to input data
- F2 = 1 because  $z_m = \frac{z_1}{2} = \frac{24}{2} = 12$
- F3 = 0 because  $n_2 / n_1 = 1$
- F4 = 0 because no reverse bending

Then, the belt width  $b$  should be calculated using the following formula

$$b = \frac{F_u \cdot F_s \cdot 10}{F_{p, spec} \cdot Z_m} = \frac{444 \cdot 1,4 \cdot 10}{28,5 \cdot 12} = 12,17 \text{ mm}$$

We will choose the next higher available width:  $20 > 12,17$

## PRE-TENSIONING

The suggested installation tension is  $F_p = 2 F_u = 2 \cdot 444 = 888 \text{ N}$

## MESHING CHECK

$$\sigma_{BS} = \frac{BS}{F_u + \frac{F_p}{2}} = \frac{7780}{444 + \frac{888}{2}} = 8,76$$

This value is lower than 11, that is the required minimum. Because of this you should check with the next wider available belt, that is 25 mm. This is the correct width as demonstrated by below calculation

$$\sigma_{BS} = \frac{BS}{F_u + \frac{F_p}{2}} = \frac{11150}{444 + \frac{888}{2}} = 12,55$$

where 11150 is the BS for a RPP5M25.

## ELONGATION

From Belt Elongation diagram at page 24 we will find:

$$\Delta l/00 = \frac{\text{Belt's Max Elongation} \cdot \frac{F_p}{2}}{BS} = \frac{3,00 \cdot 444}{11150} = 0,12 \text{ mm}$$

where Max Elongation is for the elongation of the specific length at BS.

## FINAL SELECTION

The selected belt is RPP5M25.



# CALCULATION PARAMETERS

$$F_s = \frac{F_1 + F_3 + F_4}{F_2}$$

$F_s$ : **Service Factor**

$F_1$ : **Load Factor**

$F_2$ : **Teeth in mesh Factor**

$F_3$ : **Ratio Factor**

$F_4$ : **Reverse Bending Factor**

## LOAD FACTOR ( $F_1$ )

UNIFORM LOAD	1,0		
	DAILY SERVICE IN HOURS		
	3-8 HOURS	8-16 HOURS	16-24 HOURS
With low peak load	1,2	1,4	1,6
With high peak load	1,5	1,7	1,9
With very high peak load	1,8	2,0	2,2

## TEETH IN MESH FACTOR ( $F_2$ )

TEETH IN MESH	$F_2$
12	1,0
10	0,8
8	0,6
6	0,4

## RATIO FACTOR ( $F_3$ )

SPEED RATIOS	$F_3$
1 / 1,24	0
1,25 / 1,74	0,10
1,75 / 2,49	0,20
2,50 / 3,49	0,30
3,50 and above	0,40

## REVERSE BENDING FACTOR ( $F_4$ ) - with reverse by back idler

$F_4$
0,2



# BELT INSTALLATION

## AND FEASIBILITY TABLE

### PROCEDURE TO MEASURE

The preferred procedure to measure the tension of the belt is to use a Belt Tension Meter. This device consists of a small sensing head which is held across the belt to be measured. The belt is then tapped to induce the belt to vibrate at its natural frequency. The vibrations are detected by the sensing head and the frequency of vibration is displayed on the measuring unit. The relation between belt static tension ( $T_s$ ) and frequency of vibration ( $f$ ) may be calculated using the following formula:

$$f = \frac{1}{2t} \cdot \sqrt{\frac{T_s}{m}} \quad \text{or} \quad T_s = 4 \cdot m \cdot t^2 \cdot f^2$$

where:

$T_s$ = static tension (N)	$f$ = Frequency of vibration in Hertz (Hz)
$m$ = Belt mass per unit length (kg/m)	$t$ = Free belt span length in meters (m)

### BELT AND PULLEY ALIGNMENT

For a correctly functioning system and to increase belt life, proper pulley installation is necessary: pulleys have to be parallel and aligned as shown in drawing 1 (correct configuration).

If pulleys are not parallel as in drawing 2, belt could fall causing damage to the entire equipment.

To ensure correct belt function  $\alpha$  and  $\Delta x$  must be as small as possible. For more information, please contact our technical staff.

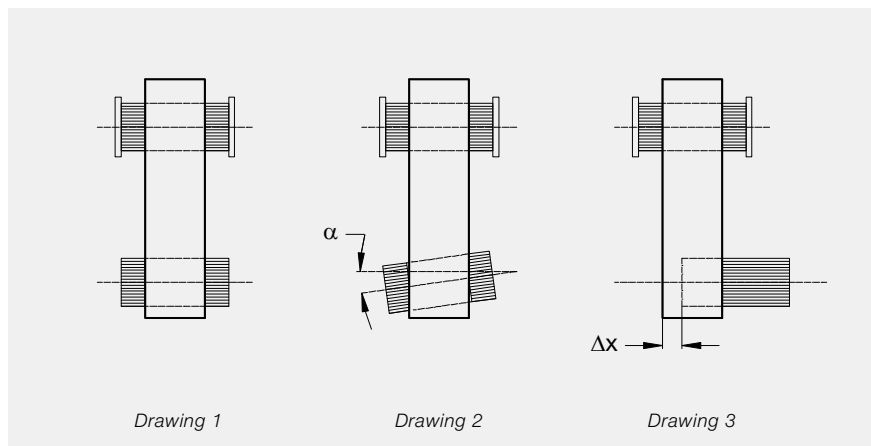

Drawing 1

Drawing 2

Drawing 3



# BELT INSTALLATION

## AND FEASIBILITY TABLE

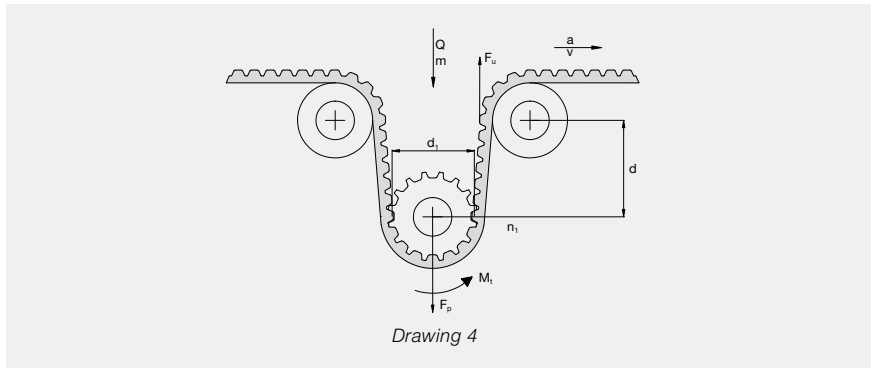

In omega applications to ensure good mesh between pulley and belt teeth and to respect belt flexibility avoiding excessive stress on cords, distance  $d$  (as drawing 4) has to be:

$$d = 4 \cdot \text{belt width} \quad \blacktriangleright \quad \text{Suggested angle } 120^\circ$$

### FEASIBILITY TABLE

Megadyne manufactures a wide range of rubber open-ended belts. In the next table a general overview is shown of the current range of products and their main characteristics. For any special belt version which might not be included, please do not hesitate to contact our Application Engineering Department or check page "Special Execution Feasibility".

Please consider that special versions might have different performance from what is declared in standard belt data pages.

FEASIBILITY TABLE														
	IMPERIAL PROFILE				PARABOLIC PROFILE									STANDARD PROFILE
	MXL	XL	L	H	RPP 3M	RPP 5M	RPP 8M	RPP 14M	SLV3 3M	SLV3 5M	SLV3 8M	TTM 8M	TTM 14M	STD 8M
<b>Standard</b>	S	S	S	P	S	P	P	P	S	S	S	S	S	S

*P = Ex stock (production process: Straight cut)*  
*S = Ex stock (production process: Spiral cut)*

# BELT FAILURES

	PROBLEMS	CAUSES	CORRECTION ACTION
EXCESSIVE BELT WEAR	<b>Unexpected wear along the complete tooth width.</b>	Belt overload.	Use a wider belt. Use a belt of a higher performance class.
	<b>Unexpected wear on one side of the tooth only.</b>	Incorrect pulley execution. Incorrect pulley alignment.	Control pulley dimensions and replace if necessary. Control and adjust pulley alignment.
	<b>Tooth bottom shows wear.</b>	Excessive belt installation tension. Incorrect pulley execution.	Calculate and adjust the belt tension. Control pulley dimensions and replace if necessary.
	<b>Tooth root shows signs of wear.</b>	Incorrect diameter of pulley.	Control pulley dimensions and replace if necessary.
	<b>The flanks of the belt show clear signs of wear.</b>	Incorrect pulley execution.	Control pulley dimensions and replace if necessary.
		Misalignment or wrong setting of pulleys.	Control pulley dimensions and replace if necessary.
		Oscillation of the axes and/or of the bearings.	Correct the positioning of the pulleys and reinforce the bearings.
<b>Damaged belt tensile member.</b>	Diameter of pulley is below specified minimum.	Increase the diameter of the pulleys or use belts and pulleys of smaller pitch.	
	Excessive moisture.	Eliminate the moisture.	
BELT DAMAGES	<b>Torn tooth along the belt.</b>	Too few teeth in mesh on the motor pulley.	Increase the number of teeth in mesh by using a bigger pulley. Use a belt of a higher performance class. Increase belt width.
		Belt overload.	Use a belt of a higher performance class or increase belt width.
		Incorrect pulley execution.	Control pulley dimensions and replace if necessary.
	<b>Rupture of tensile member.</b>	Belt overload.	Use a belt of a higher performance class or increase belt width.
		Diameter of pulley is below specified minimum.	Increase the diameter of the pulleys
		Tooth jump due to missing belt installation tension.	Calculate and adjust the belt tension.
	<b>Breaks or cracks in the back side of the belt.</b>	Exposure to temperatures which are out of the admissible temperature range.	Protect the transmission by extreme temperatures.
		Diameter of pulley is below specified minimum.	Increase the diameter of the pulleys.
	<b>Softening of the top surface of the belt.</b>	Excessive exposure to UV radiation.	Reduce exposure to UV radiation.
		Operation with excessive amount of oil.	Protect the belt from oil.
<b>Apparent elongation of the belt.</b>	Reduction of centre distance due to bearings not being firmly fixed.	Restore the initial centre distance and strengthen the bearings.	
DRIVE FUNCTION PROBLEMS	<b>Belt overriding the pulley flanks.</b>	Faulty installation of the flanks.	Reinstall the flanks properly.
		Misalignment of pulleys.	Align pulleys.
	<b>Excessive wear on the pulley teeth.</b>	Excessive overloading.	Use a wider belt.
		Excessive belt installation tension.	Calculate and adjust the belt tension.
		Pulley material insufficient hard.	Harden the pulley surface.
	<b>Drive excessively noisy.</b>	Pulleys out of line.	Align pulleys.
Excessive belt installation tension.		Calculate and adjust the belt tension.	
	Incorrect pulley execution.	Control pulley dimensions and replace if necessary.	

# MXL OPEN-ENDED

## SPIRAL CUT



<b>STANDARD WIDTHS (inch)</b>	<b>025</b>	<b>031</b>	<b>037</b>
<b>STANDARD WIDTHS (mm)</b>	<b>6,35</b>	<b>7,87</b>	<b>9,39</b>
Weight (gr/m)	8,5	10,5	13,0
<b>Standard roll length and tolerance (m)</b>	<b>160 ± 5</b>	<b>130 ± 5</b>	<b>110 ± 5</b>

Standard compound: **Chloroprene 74 ± 4 ShA**

Standard tooth cover: **nylon fabric**

Standard cord: **glass**

Standard width tolerance: **± 0,4 mm**

Standard thickness tolerance: **± 0,25 mm**

Standard length tolerance: **± 0,8 mm/m**

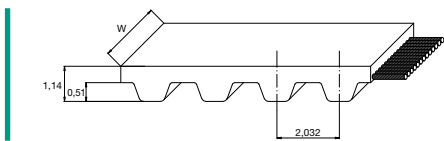

## TRACTION RESISTANCE AND ELONGATION DATA

### CALCULATION PARAMETERS

BELT WIDTH (inch)	BREAKING STRENGTH (N)
025	640
031	790
037	850

### BELT ELONGATION

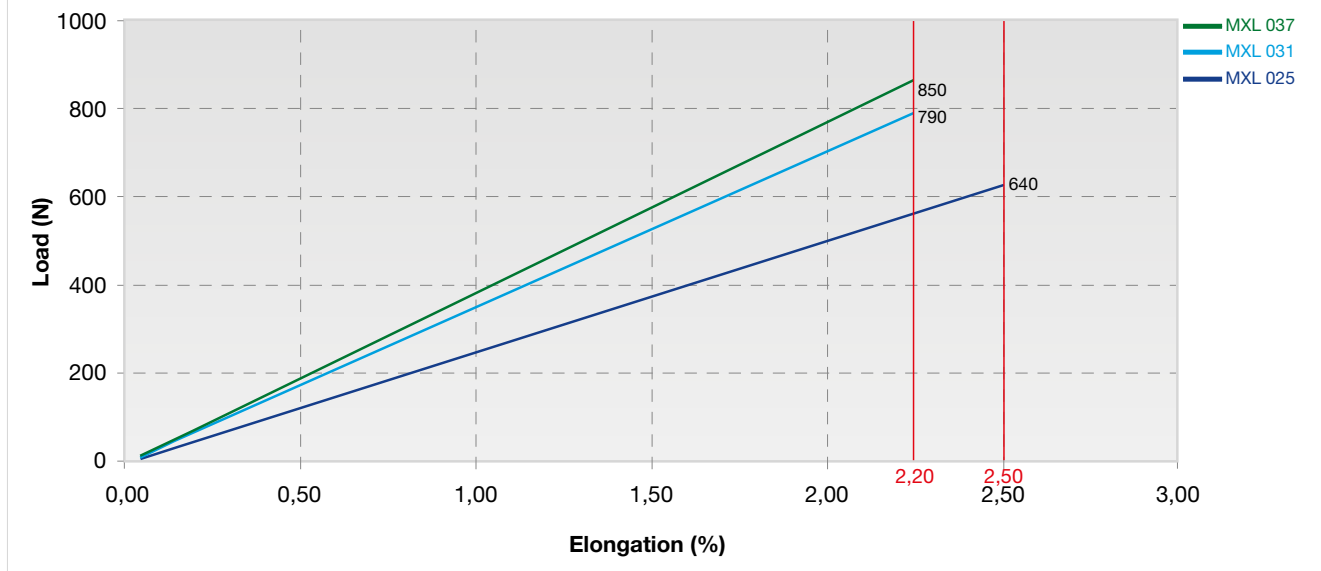

RUBBER OPEN-ENDED

# MXL OPEN-ENDED

## SPIRAL CUT

### TOOTH RESISTANCE

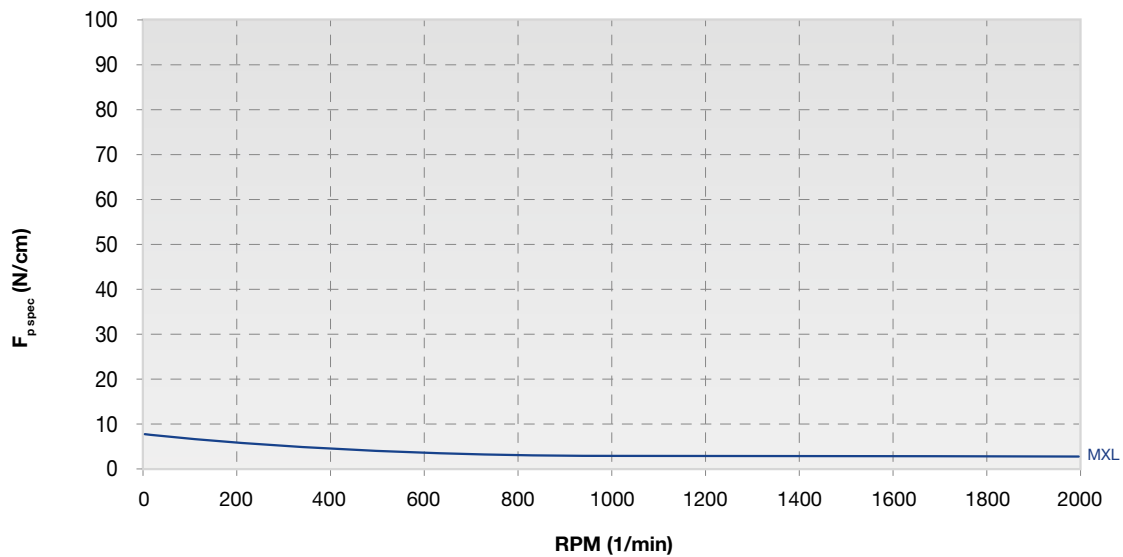

RPM (1/min)	0	10	50	100	200	500	1000	1500	2000
$F_{p\ spec}$ (N/cm)	6,0	5,8	5,5	5,0	4,5	4,0	3,5	3,3	3,0

### FLEXION RESISTANCE

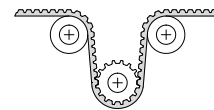
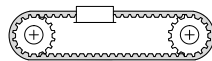

	$z_{min}$	$z_{min}$	IDLER MIN DIA (mm)
Glass cords	12	14	20

### PULLEYS

(FOR MORE DETAILS PLEASE SEE OUR PULLEY CATALOGUE)

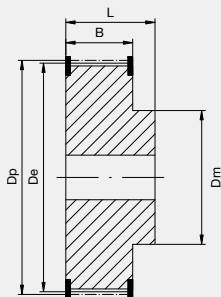

N° TEETH	DP	DE
12	7,76	7,25
13	8,41	7,90
14	9,06	8,55
15	9,70	9,19
16	10,35	9,84
17	11,00	10,49
18	11,64	11,13
19	12,29	11,78
20	12,94	12,43
21	13,58	13,07
22	14,23	13,72
24	15,52	15,01
26	16,82	16,30

N° TEETH	DP	DE
28	18,11	17,60
30	19,40	18,89
32	20,70	20,19
34	21,99	21,48
36	23,29	22,78
40	25,87	25,36
42	27,17	26,66
44	28,46	27,95
48	31,05	30,54
60	38,81	38,30
65	42,04	41,53
72	46,57	46,06

RUBBER OPEN-ENDED



# XL OPEN-ENDED

## SPIRAL CUT



<b>STANDARD WIDTHS (inch)</b>	<b>025</b>	<b>031</b>	<b>037</b>
<b>STANDARD WIDTHS (mm)</b>	<b>6,35</b>	<b>7,87</b>	<b>9,39</b>
Weight (gr/m)	14,0	17,5	21,0
<b>Standard roll length and tolerance (m)</b>	<b>50 ± 5</b>	<b>50 ± 5</b>	<b>50 ± 5</b>

Standard compound: **Chloroprene 74 ± 4 ShA**

Standard tooth cover: **nylon fabric**

Standard cord: **glass**

Standard width tolerance: **-0,8/+0,4 mm**

Standard thickness tolerance: **± 0,25 mm**

Standard length tolerance: **± 0,8 mm/m**

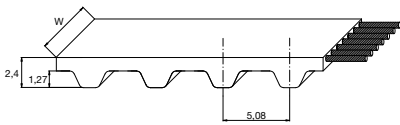

## TRACTION RESISTANCE AND ELONGATION DATA

### CALCULATION PARAMETERS

BELT WIDTH (inch)	BREAKING STRENGTH (N)
025	930
031	1300
037	1400

### BELT ELONGATION

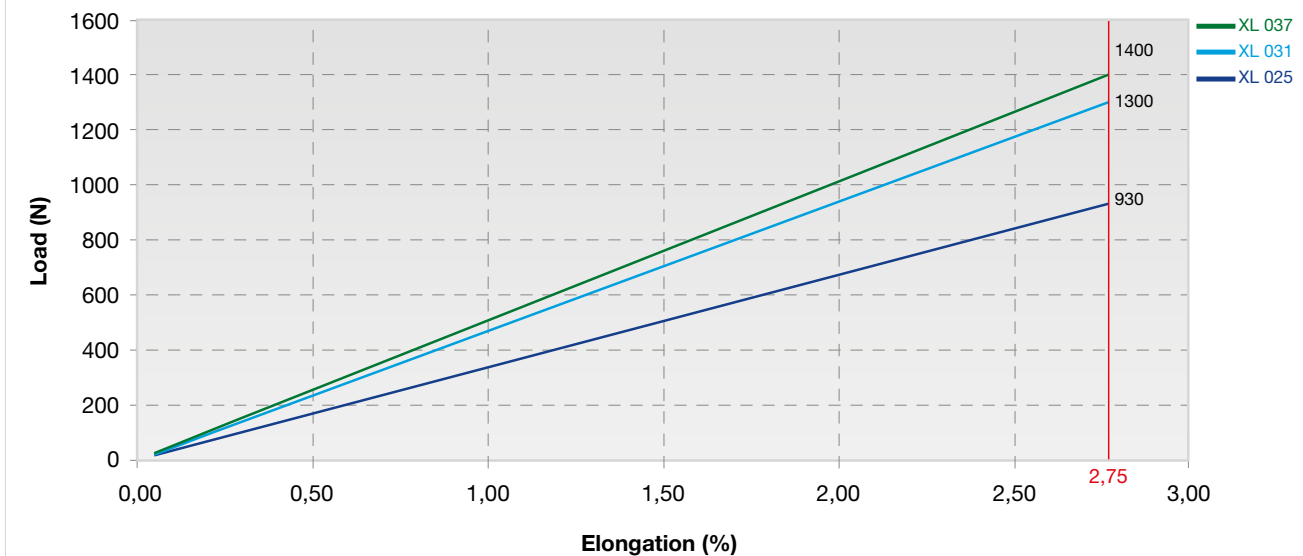

RUBBER OPEN-ENDED

# XL OPEN-ENDED

## SPIRAL CUT

### TOOTH RESISTANCE

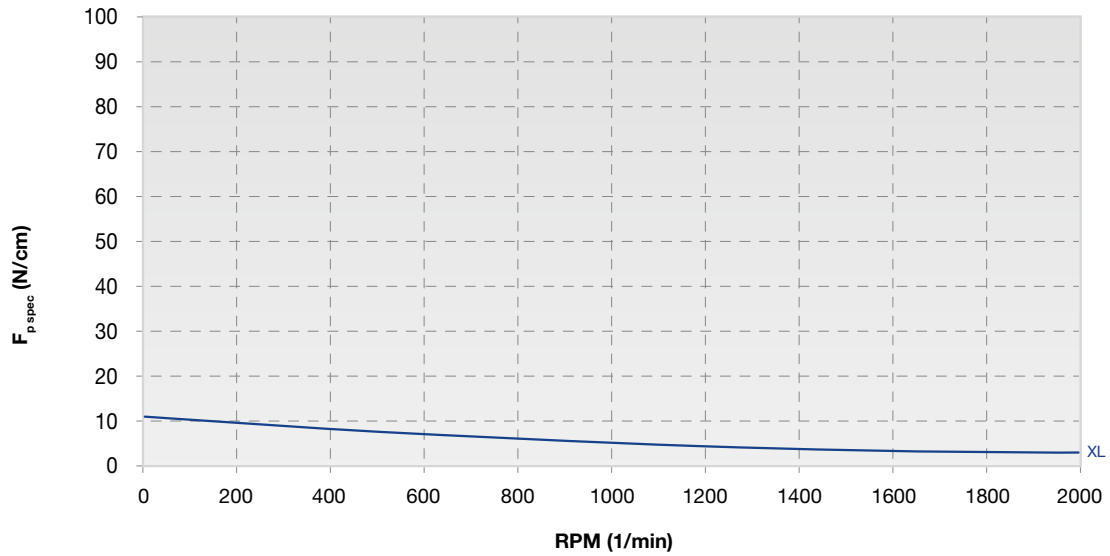

RPM (1/min)	0	10	50	100	200	500	1000	1500	2000
$F_{p\ spec}$ (N/cm)	10,0	9,8	9,5	9,0	8,0	7,3	6,5	6,0	5,8

### FLEXION RESISTANCE

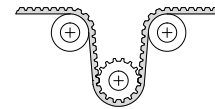
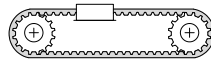

	$z_{min}$	$z_{min}$	IDLER MIN DIA (mm)
Glass cords	10	12	35

### PULLEYS

(FOR MORE DETAILS PLEASE SEE OUR PULLEY CATALOGUE)

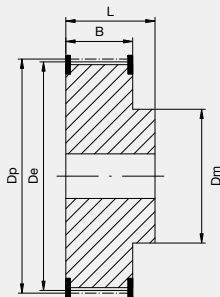

N° TEETH	DP	DE
10	16,17	15,66
11	17,79	17,28
12	19,40	18,89
13	21,02	20,51
14	22,64	22,13
15	24,26	23,75
16	25,87	25,36
17	27,49	26,98
18	29,11	28,60
19	30,72	30,21
20	32,34	31,83
21	33,96	33,45
22	35,57	35,07
24	38,81	38,30

N° TEETH	DP	DE
26	42,04	41,53
27	43,66	43,16
28	45,28	44,77
29	46,89	46,38
30	48,51	48,00
32	51,74	51,23
34	54,98	54,47
35	56,60	56,09
36	58,21	57,70
38	61,45	60,94
39	63,06	62,55
40	64,68	64,17
42	67,91	67,40
44	71,15	70,64

RUBBER OPEN-ENDED



# L OPEN-ENDED

## SPIRAL CUT

<b>STANDARD WIDTHS (inch)</b>	<b>050</b>	<b>075</b>	<b>100</b>
<b>STANDARD WIDTHS (mm)</b>	<b>12,70</b>	<b>19,05</b>	<b>25,40</b>
Weight (gr/m)	42	62	84
<b>Standard roll length and tolerance (m)</b>	<b>50 -7/+5</b>	<b>50 -7/+5</b>	<b>70 ± 5</b>

Standard compound: **Chloroprene 74 ± 4 ShA**

Standard tooth cover: **nylon fabric**

Standard cord: **glass**

Standard width tolerance: **-0,8/+0,4 mm**

Standard thickness tolerance: **± 0,25 mm**

Standard length tolerance: **± 0,8 mm/m**

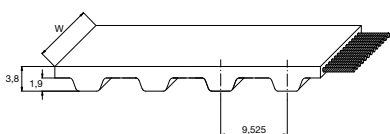

## TRACTION RESISTANCE AND ELONGATION DATA

### CALCULATION PARAMETERS

BELT WIDTH (inch)	BREAKING STRENGTH (N)
050	2350
075	3480
100	4220

### BELT ELONGATION

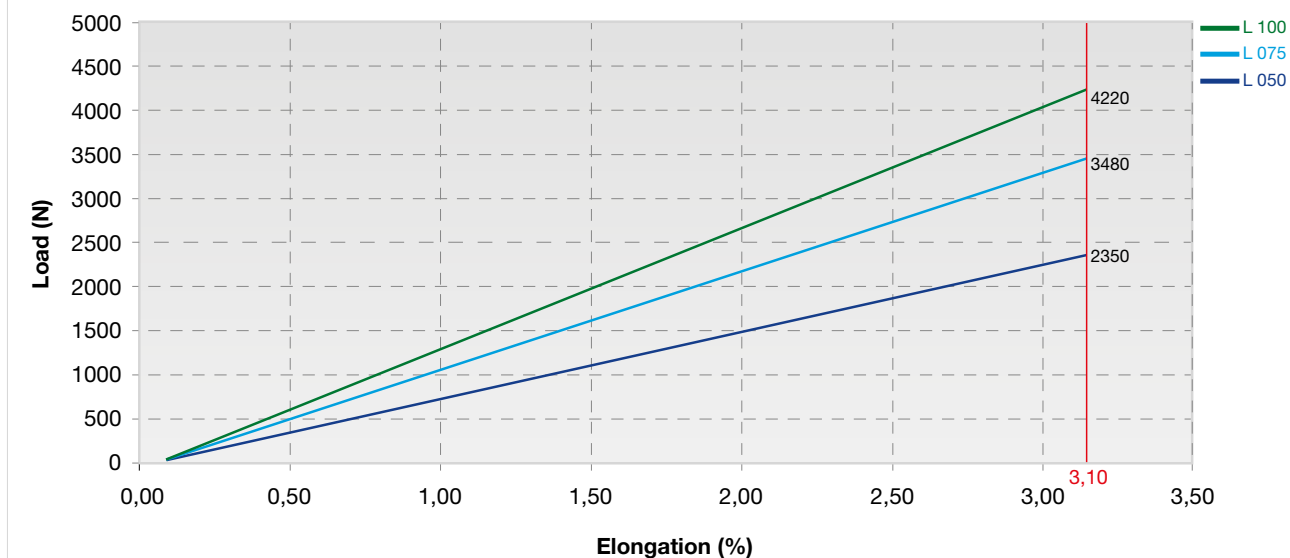

RUBBER OPEN-ENDED

# L OPEN-ENDED

## SPIRAL CUT

### TOOTH RESISTANCE

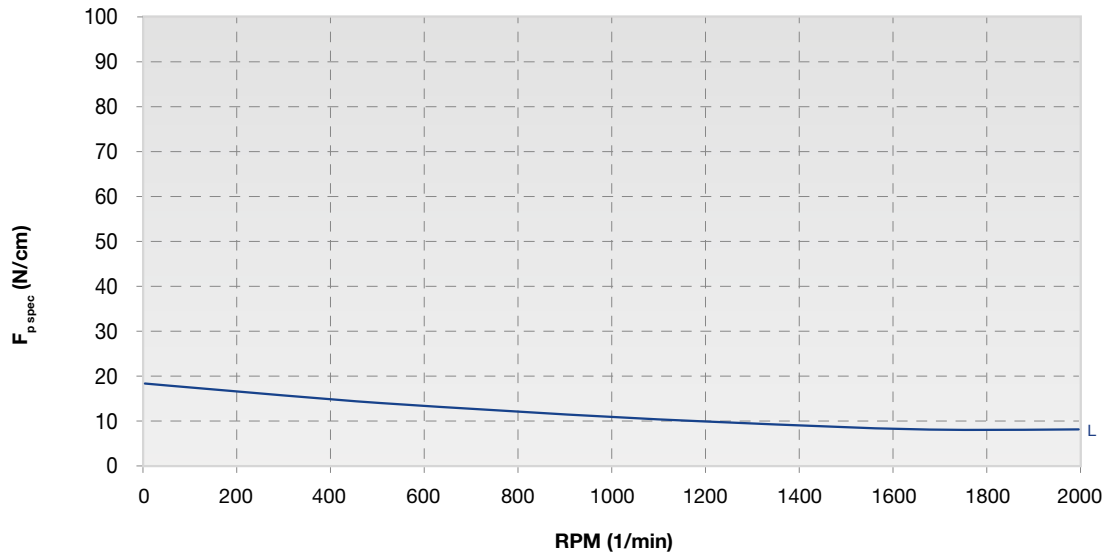

RPM (1/min)	0	10	50	100	200	500	1000	1500	2000
$F_{p\ spec}$ (N/cm)	18	18	17	17	16	13	11	10	9

### FLEXION RESISTANCE

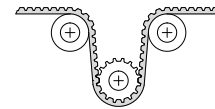
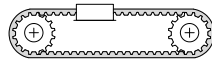

	$z_{min}$	$z_{min}$	IDLER MIN DIA (mm)
Glass cords	10	14	60

### PULLEYS

(FOR MORE DETAILS PLEASE SEE OUR PULLEY CATALOGUE)

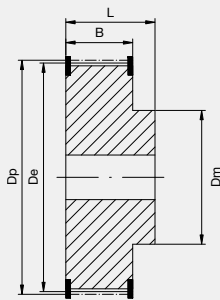

N° TEETH	DP	DE
10	31,27	30,51
12	36,38	35,62
14	42,45	41,69
15	45,48	44,72
16	48,51	47,75
17	51,54	50,78
18	54,57	53,81
19	57,61	56,85
20	60,64	59,88
21	63,67	62,91
22	66,70	65,94
23	69,73	68,97
24	72,77	72,01

N° TEETH	DP	DE
25	75,80	75,04
26	78,83	78,07
27	81,86	81,10
28	84,89	84,13
29	87,93	87,17
30	90,96	90,20
32	97,02	96,26
34	103,08	102,32
36	109,15	108,39
40	121,28	120,52
44	133,40	132,64
48	145,53	144,76

RUBBER OPEN-ENDED

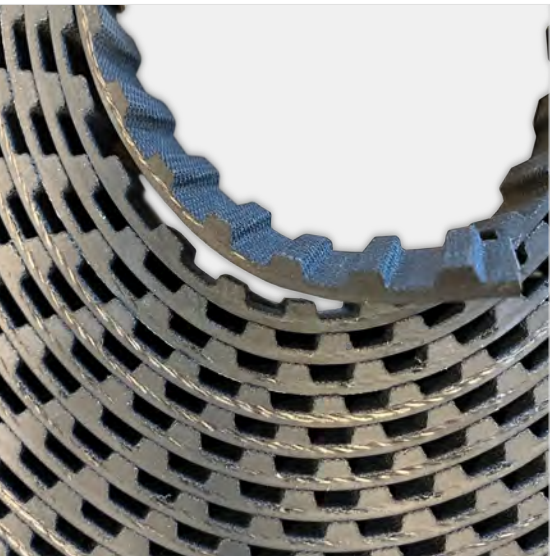

# H OPEN-ENDED

## STRAIGHT CUT

<b>STANDARD WIDTHS (inch)</b>	<b>050</b>	<b>075</b>	<b>100</b>	<b>150</b>	<b>200</b>	<b>300</b>
<b>STANDARD WIDTHS (mm)</b>	<b>12,70</b>	<b>19,05</b>	<b>25,40</b>	<b>38,10</b>	<b>50,80</b>	<b>76,20</b>
Weight (gr/m)	55	82	110	165	220	330
<b>Standard roll length and tolerance (m)</b>	<b>50 ± 5</b>	<b>50 ± 5</b>	<b>50 ± 5</b>	<b>50 ± 5</b>	<b>50 ± 5</b>	<b>50 ± 5</b>

Standard compound: **Chloroprene 74 ± 4 ShA**

Standard tooth cover: **nylon fabric**

Standard cord: **glass**

Standard width tolerance: **± 0,8 mm**

Standard thickness tolerance: **± 0,60 mm**

Standard length tolerance: **± 0,8 mm/m**

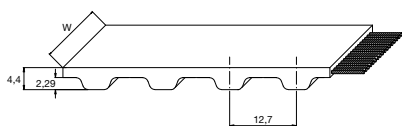

## TRACTION RESISTANCE AND ELONGATION DATA

### CALCULATION PARAMETERS

BELT WIDTH (inch)	BREAKING STRENGTH (N)
050	4800
075	8710
100	10495
150	15370
200	20990
300	30740

### BELT ELONGATION

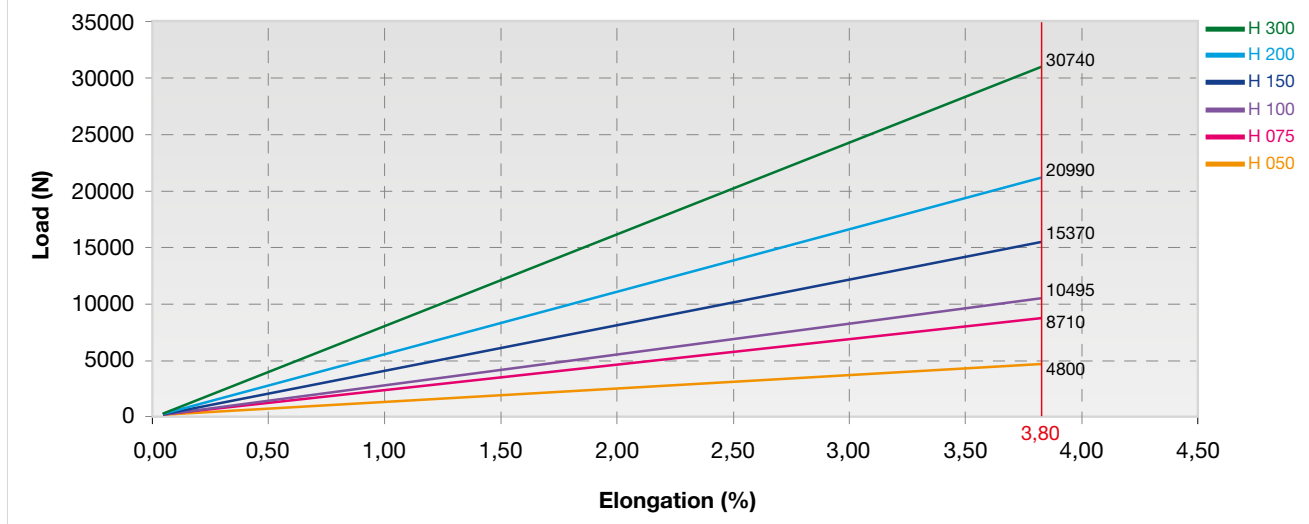

RUBBER OPEN-ENDED

# H OPEN-ENDED

## STRAIGHT CUT

### TOOTH RESISTANCE

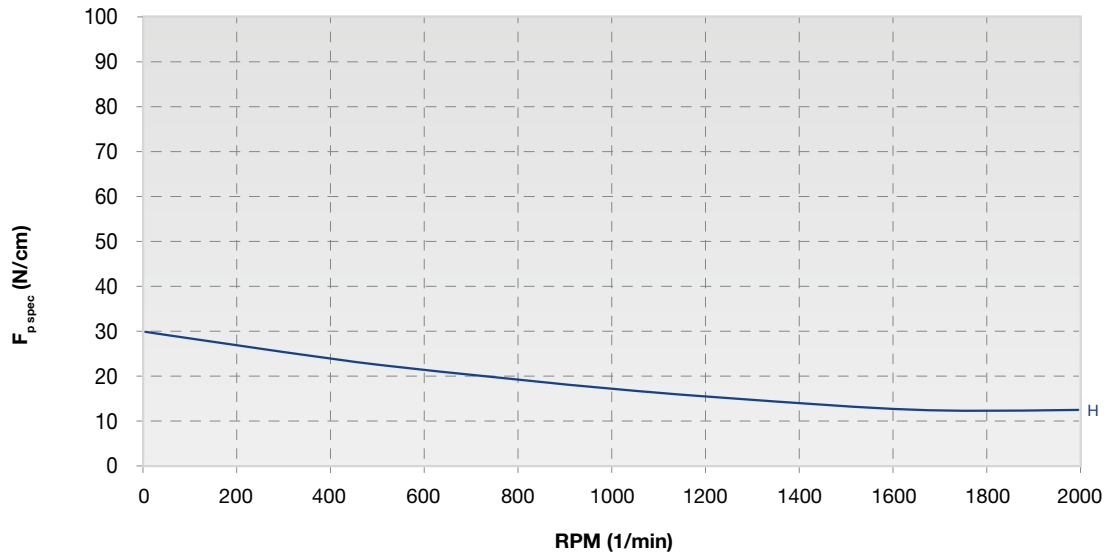

RPM (1/min)	0	10	50	100	200	500	1000	1500	2000
F <sub>p spec</sub> (N/cm)	30	29	28	27	25	22	18	16	14

### FLEXION RESISTANCE

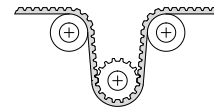
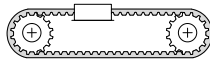

	$z_{min}$	$z_{min}$	IDLER MIN DIA (mm)
Glass cords	14	14	80

### PULLEYS

(FOR MORE DETAILS PLEASE SEE OUR PULLEY CATALOGUE)

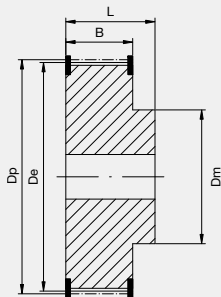

N° TEETH	DP	DE
14	56,60	55,23
15	60,64	59,27
16	64,68	63,31
17	68,72	67,35
18	72,77	71,40
19	76,81	75,44
20	80,85	79,48
21	84,89	83,52
22	88,94	87,57
23	92,98	91,61
24	97,02	95,65
25	101,06	99,69
26	105,11	103,74
27	109,15	107,78

N° TEETH	DP	DE
28	113,19	111,82
29	117,23	115,86
30	121,28	119,91
32	129,36	127,99
33	133,40	132,03
34	137,45	136,08
35	141,49	140,12
36	145,53	144,16
38	153,62	152,25
40	161,70	160,33
44	177,87	176,50
48	194,04	192,67
52	210,21	208,84
60	242,55	241,18

RUBBER OPEN-ENDED

# RPP3 OPEN-ENDED

## SPIRAL CUT



STANDARD WIDTHS (mm)	9	12	15
Weight (gr/m)	21	28	35
Standard roll length and tolerance (m)	50 ± 5	50 ± 5	50 ± 5

Standard compound: **Chloroprene 74 ± 4 ShA**

Standard tooth cover: **nylon fabric**

Standard cord: **glass**

Standard width tolerance: **± 0,4 mm**

Standard thickness tolerance: **± 0,25 mm**

Standard length tolerance: **± 0,8 mm/m**

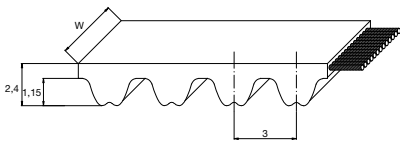

## TRACTION RESISTANCE AND ELONGATION DATA

### CALCULATION PARAMETERS

BELT WIDTH (mm)	BREAKING STRENGTH (N)
9	1570
12	2100
15	2630

### BELT ELONGATION

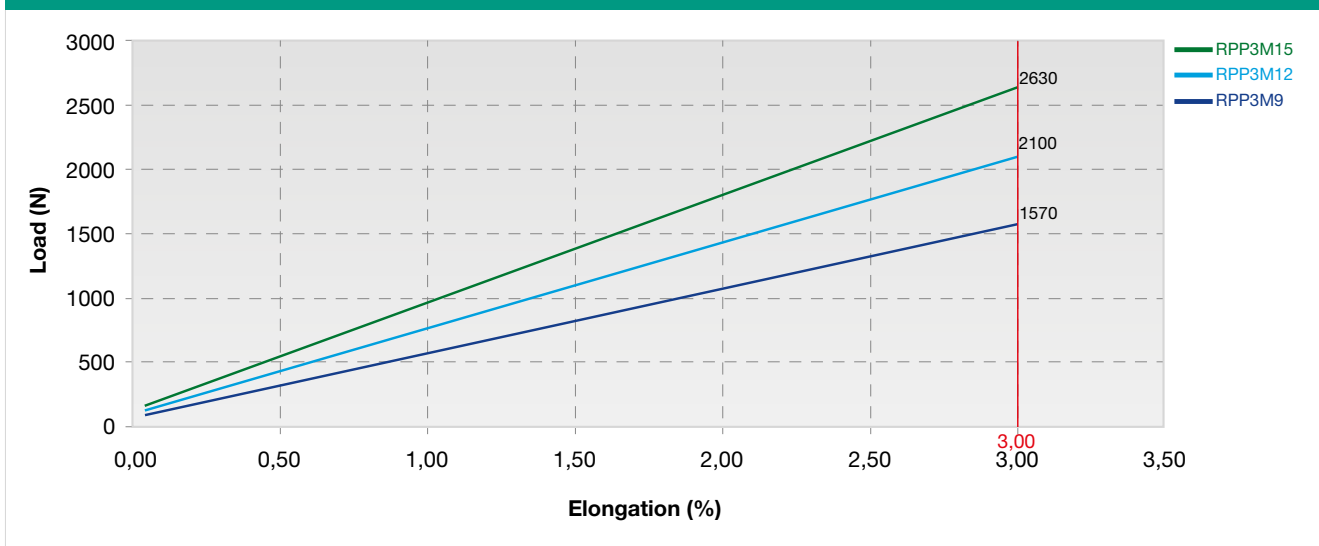

# RPP3 OPEN-ENDED

## SPIRAL CUT

### TOOTH RESISTANCE

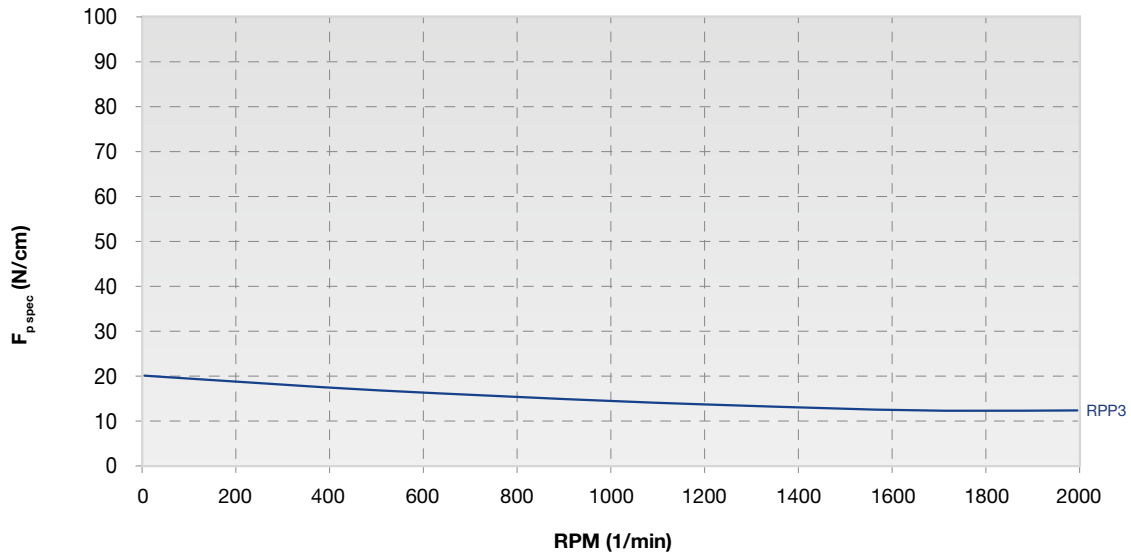

RPM (1/min)	0	10	50	100	200	500	1000	1500	2000
$F_{p\ spec}$ (N/cm)	21	21	20	20	19	17	15	14	13

Meshing Check is strongly suggested because of the belt's elasticity.

To safeguard the correct meshing it might be possible that Meshing Check leads to a wider belt.

### FLEXION RESISTANCE

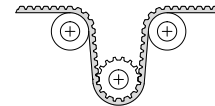
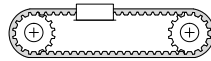

	$z_{min}$	$z_{min}$	IDLER MIN DIA (mm)
Glass cords	10	14	30

### PULLEYS

(FOR MORE DETAILS PLEASE SEE OUR PULLEY CATALOGUE)

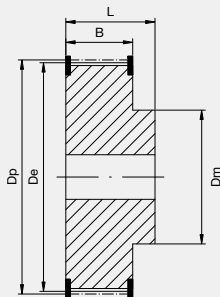

N° TEETH	DP	DE
10	9,55	8,79
12	11,46	10,70
14	13,37	12,61
16	15,28	14,52
18	17,19	16,43
20	19,10	18,34
21	20,05	19,29
22	21,01	20,25
24	22,92	22,16
26	24,83	24,07

N° TEETH	DP	DE
28	26,74	25,98
30	28,65	27,89
32	30,56	29,80
36	34,38	33,62
40	38,20	37,44
44	42,02	41,25
48	45,84	45,07
60	57,30	56,53
72	68,75	67,99



# RPP5 OPEN-ENDED

## STRAIGHT CUT



STANDARD WIDTHS (mm)	9	12	15	20	25	30
Weight (gr/m)	40	54	67	90	115	138
Standard roll length and tolerance (m)	50 ± 5	50 ± 5	50 ± 5	50 ± 5	50 ± 5	50 ± 5

Standard compound: **Chloroprene 74 ± 4 ShA**

Standard tooth cover: **nylon fabric**

Standard cord: **glass**

Standard width tolerance: **± 0,5 mm**

Standard thickness tolerance: **± 0,25 mm**

Standard length tolerance: **± 0,8 mm/m**

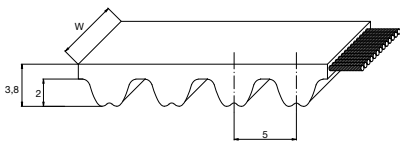

## TRACTION RESISTANCE AND ELONGATION DATA

### CALCULATION PARAMETERS

BELT WIDTH (mm)	BREAKING STRENGTH (N)
9	3490
12	5040
15	5820
20	7780
25	11150
30	12950

### BELT ELONGATION

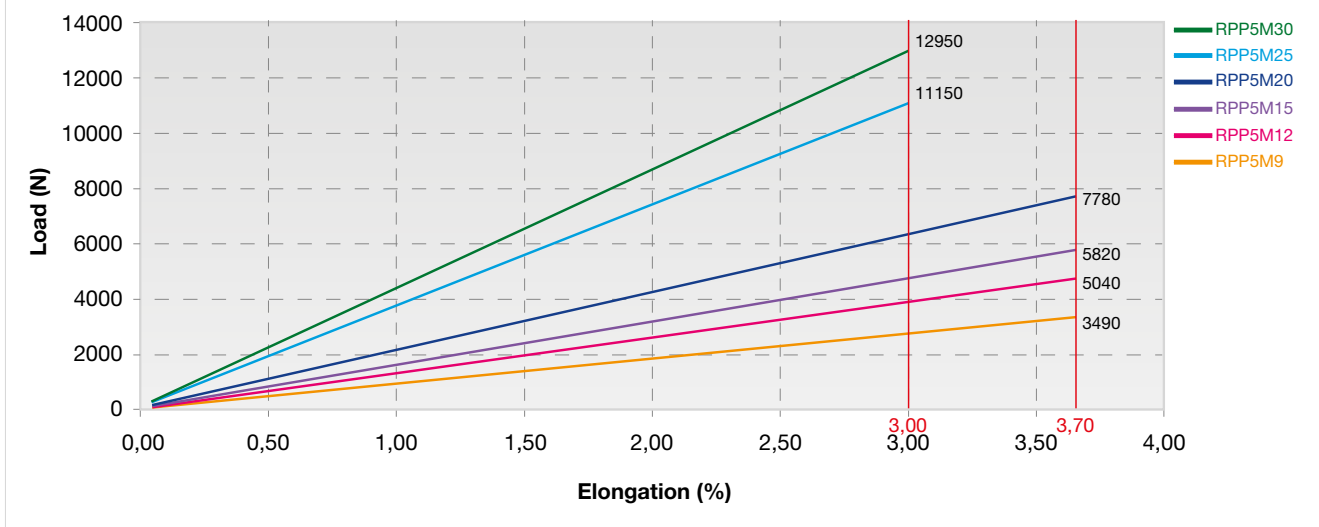

# RPP5 OPEN-ENDED

## STRAIGHT CUT

### TOOTH RESISTANCE

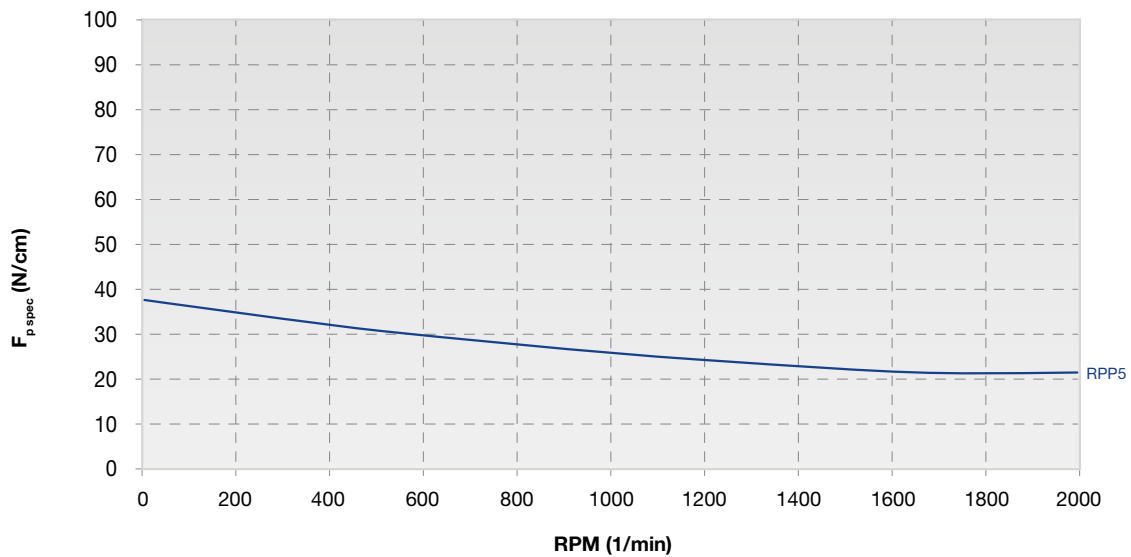

RPM (1/min)	0	10	50	100	200	500	1000	1500	2000
$F_{p\ spec}$ (N/cm)	38	38	37	36	34	31	26	23	22

Meshing Check is strongly suggested because of the belt's elasticity.

To safeguard the correct meshing it might be possible that Meshing Check leads to a wider belt.

### FLEXION RESISTANCE

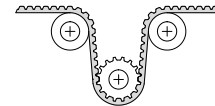
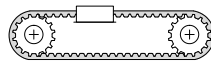

	$z_{min}$	$z_{min}$	IDLER MIN DIA (mm)
Glass cords	12	16	50

### PULLEYS

(FOR MORE DETAILS PLEASE SEE OUR PULLEY CATALOGUE)

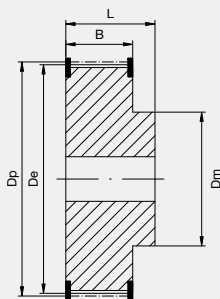

N° TEETH	DP	DE
12	19,10	17,96
14	22,28	21,14
15	23,87	22,73
16	25,46	24,32
18	28,65	27,50
20	31,83	30,69
21	33,42	32,28
22	35,01	33,87
24	38,20	37,05
26	41,38	40,24

N° TEETH	DP	DE
28	44,56	43,42
30	47,75	46,60
32	50,93	49,79
36	57,30	56,15
40	63,66	62,52
44	70,03	68,89
48	76,39	75,25
60	95,49	94,35
72	114,59	113,45

RUBBER OPEN-ENDED

# RPP8 OPEN-ENDED

## STRAIGHT CUT



STANDARD WIDTHS (mm)	10	15	20	25	30	50	85
Weight (gr/m)	55	83	110	138	166	276	470
Standard roll length and tolerance (m)	50 ± 5	50 ± 5	50 ± 5	50 ± 5	50 ± 5	50 ± 5	50 ± 5

Standard compound: **Chloroprene 74 ± 4 ShA**

Standard tooth cover: **nylon fabric**

Standard cord: **glass**

Standard width tolerance: **± 0,5 mm**

Standard thickness tolerance: **± 0,40 mm**

Standard length tolerance: **± 0,8 mm/m**

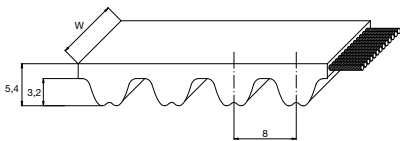

## TRACTION RESISTANCE AND ELONGATION DATA

### CALCULATION PARAMETERS

BELT WIDTH (mm)	BREAKING STRENGTH (N)
10	4200
15	6650
20	7850
25	11100
30	14440
50	24100
85	40950

### BELT ELONGATION

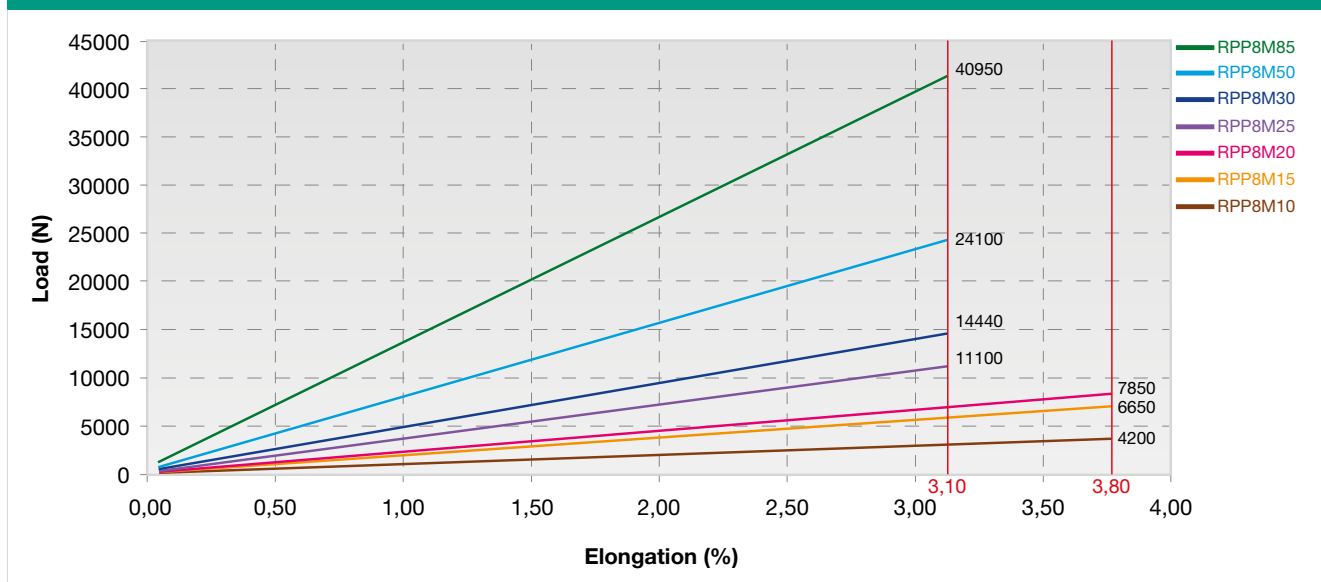

# RPP8 OPEN-ENDED

## STRAIGHT CUT

### TOOTH RESISTANCE

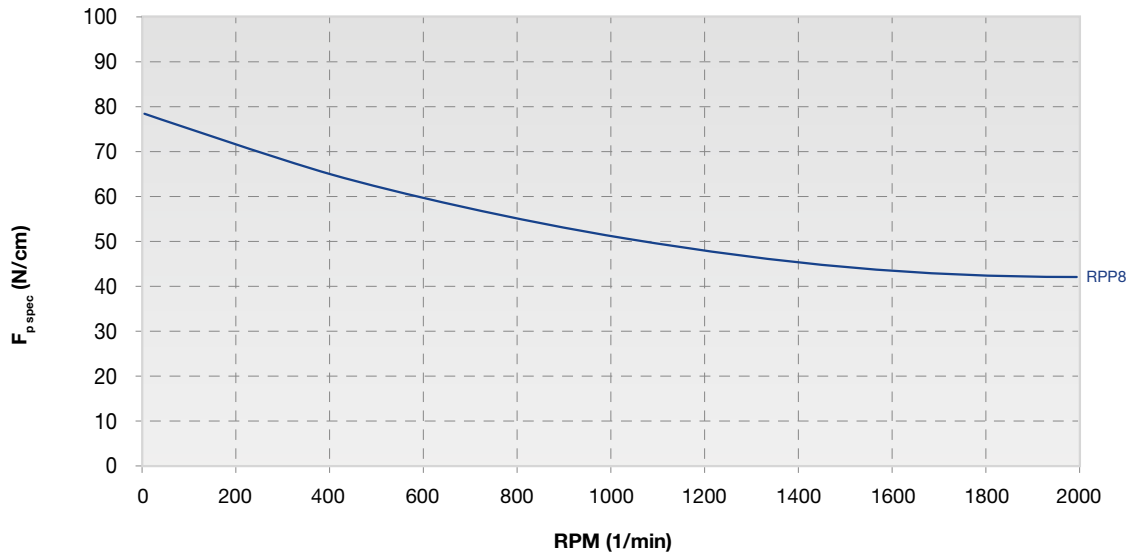

RPM (1/min)	0	10	50	100	200	500	1000	1500	2000
$F_{p\text{ spec}}$ (N/cm)	78	77	76	74	70	61	51	47	44

Meshing Check is strongly suggested because of the belt's elasticity.

To safeguard the correct meshing it might be possible that Meshing Check leads to a wider belt.

### FLEXION RESISTANCE

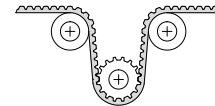
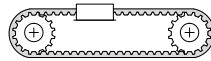

	$z_{min}$	$z_{min}$	IDLER MIN DIA (mm)
Glass cords	22	22	100

### PULLEYS

(FOR MORE DETAILS PLEASE SEE OUR PULLEY CATALOGUE)

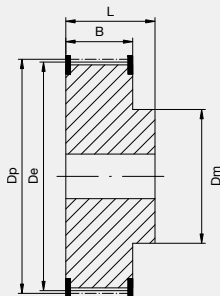

N° TEETH	DP	DE
22	56,02	54,65
24	61,12	59,74
26	66,21	64,84
28	71,30	69,93
30	76,39	75,02
32	81,49	80,12
34	86,58	85,21
36	91,67	90,30
38	96,77	95,39
40	101,86	100,49
44	112,05	110,67

N° TEETH	DP	DE
48	122,23	120,86
54	137,51	136,14
64	162,97	161,60
72	183,35	181,97
80	203,72	202,35
90	229,18	227,81
112	285,20	283,83
144	366,69	365,32
168	427,81	426,44
192	488,92	487,55

RUBBER OPEN-ENDED

# RPP8 OPEN-ENDED

## STEEL CORDS - STRAIGHT CUT



STANDARD WIDTHS (mm) *	10	15	20	30	50
Weight (gr/m)	96	149	202	309	517
Standard roll length and tolerance (m)	30 -0/+1	30 -0/+1	30 -0/+1	30 -0/+1	30 -0/+1

\* Wider belts on request

Standard compound:	<b>EPDM 89 ± 4 ShA</b>
Standard tooth cover:	<b>nylon fabric</b>
Standard back	<b>grinded</b>
Standard cord:	<b>S and Z torsion zinked steel</b>
Standard width tolerance for W ≤ 30:	<b>± 0,8 mm</b>
Standard width tolerance for W = 50:	<b>± 1,2 mm</b>
Standard thickness tolerance:	<b>± 0,3 mm</b>
Standard length tolerance:	<b>± 0,8 mm/m</b>

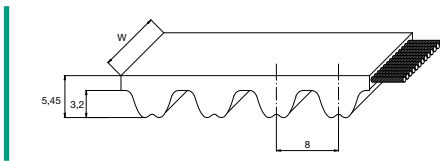

## TRACTION RESISTANCE AND ELONGATION DATA

### CALCULATION PARAMETERS

BELT WIDTH (mm)	BREAKING STRENGTH (N)
10	6400
15	11200
20	16870
30	28200
50	43200

### BELT ELONGATION

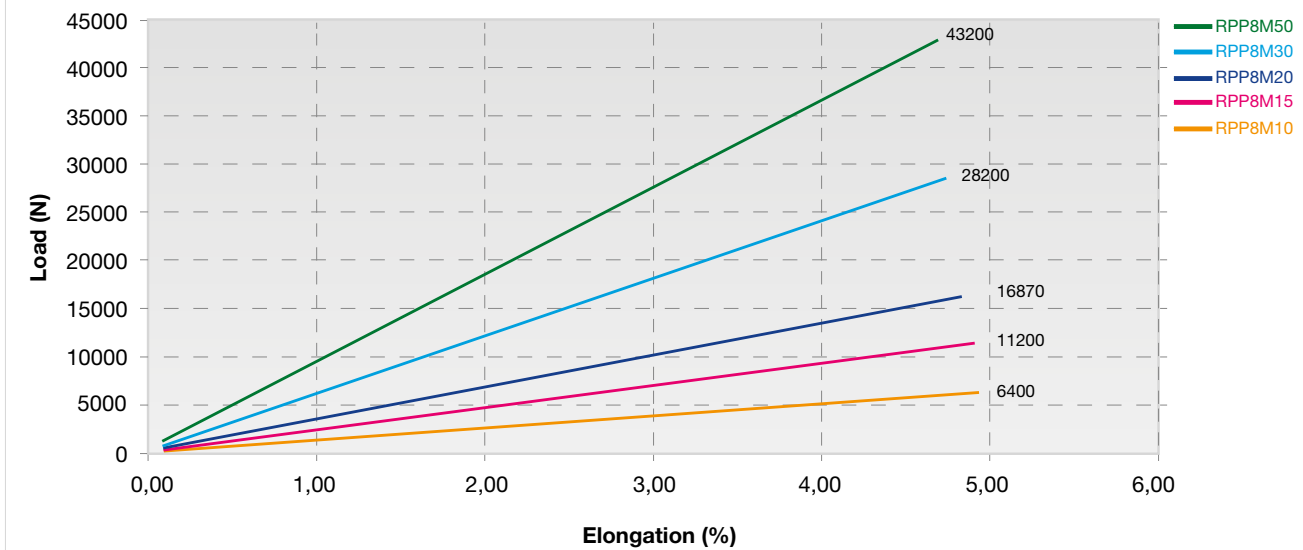

# RPP8 OPEN-ENDED

## STEEL CORDS - STRAIGHT CUT

### TOOTH RESISTANCE

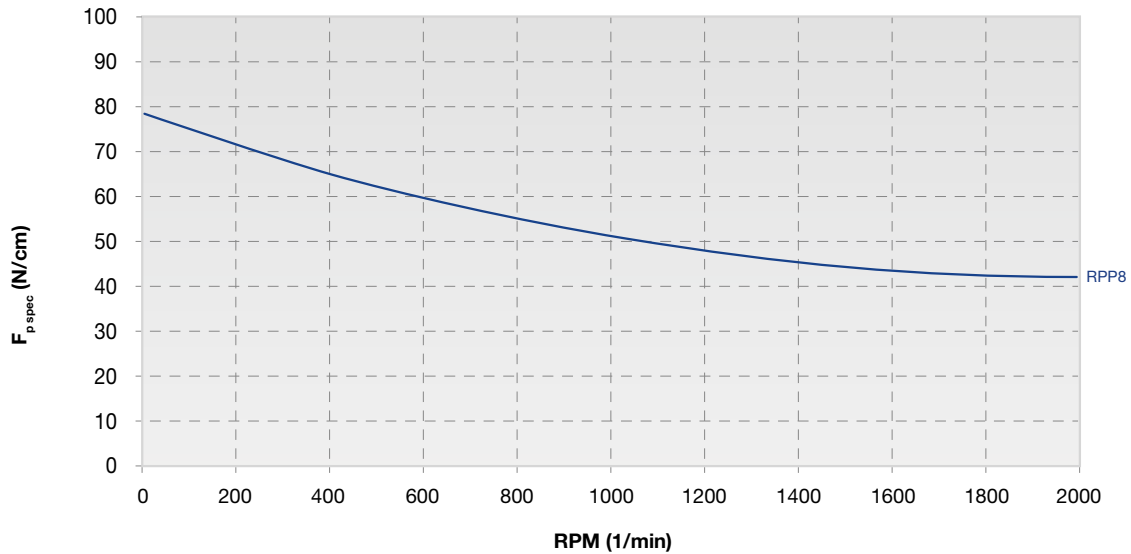

RPM (1/min)	0	10	50	100	200	500	1000	1500	2000
$F_{p\text{ spec}}$ (N/cm)	78	77	76	74	70	61	51	47	44

Meshing Check is strongly suggested because of the belt's elasticity.

To safeguard the correct meshing it might be possible that Meshing Check leads to a wider belt.

### FLEXION RESISTANCE

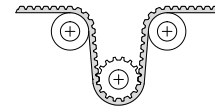
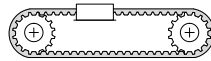

	$z_{min}$	$z_{min}$	IDLER MIN DIA (mm)
Glass cords	22	30	150

### PULLEYS

(FOR MORE DETAILS PLEASE SEE OUR PULLEY CATALOGUE)

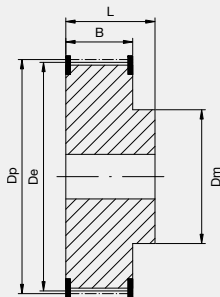

N° TEETH	DP	DE
22	56,02	54,65
24	61,12	59,74
26	66,21	64,84
28	71,30	69,93
30	76,39	75,02
32	81,49	80,12
34	86,58	85,21
36	91,67	90,30
38	96,77	95,39

N° TEETH	DP	DE
40	101,86	100,49
44	112,05	110,67
48	122,23	120,86
54	137,51	136,14
64	162,97	161,60
72	183,35	181,97
80	203,72	202,35
90	229,18	227,81

RUBBER OPEN-ENDED

# RPP14 OPEN-ENDED

## STEEL CORDS - STRAIGHT CUT



STANDARD WIDTHS (mm) *	25	40	55	85
Weight (gr/m)	351	562	772	1194
Standard roll length and tolerance (m)	30 -0/+1	30 -0/+1	30 -0/+1	30 -0/+1

\* Wider belts on request

Standard compound:	<b>EPDM 89 ± 4 ShA</b>
Standard tooth cover:	<b>nylon fabric</b>
Standard back:	<b>grinded</b>
Standard cord:	<b>S and Z torsion zinked steel</b>
Standard width tolerance:	<b>± 1,35 mm</b>
Standard thickness tolerance:	<b>± 0,4 mm</b>
Standard length tolerance:	<b>± 0,8 mm/m</b>

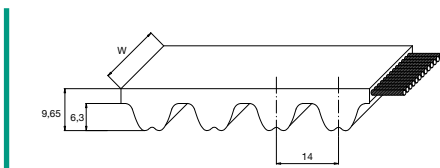

## TRACTION RESISTANCE AND ELONGATION DATA

### CALCULATION PARAMETERS

BELT WIDTH (mm)	BREAKING STRENGTH (N)
25	49000
40	81000
55	119000
85	182000

### BELT ELONGATION

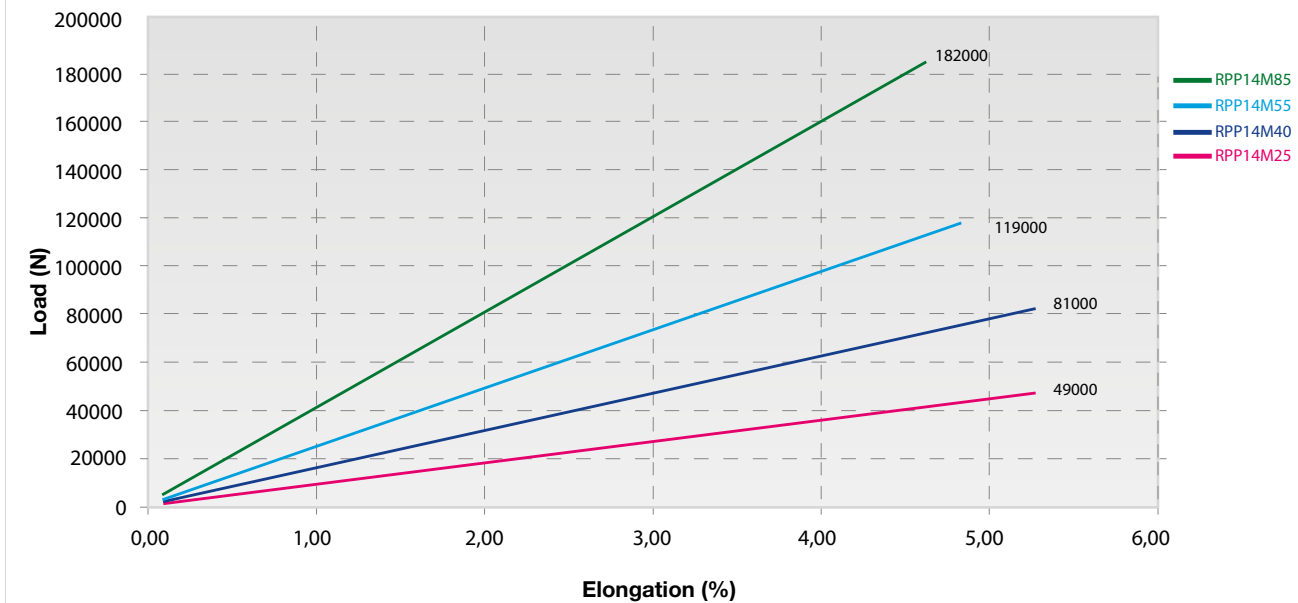

# RPP14 OPEN-ENDED

## STEEL CORDS - STRAIGHT CUT

### TOOTH RESISTANCE

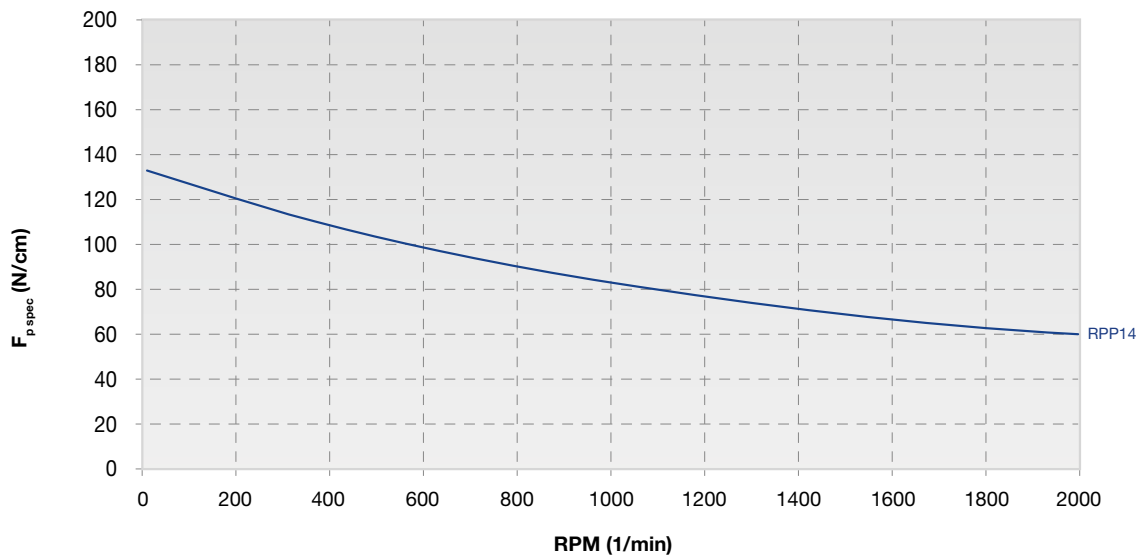

RPM (1/min)	0	10	50	100	200	500	1000	1500	2000
$F_{p\ spec}$ (N/cm)	135	132	129	123	114	97	81	73	60

Meshing Check is strongly suggested because of the belt's elasticity.

To safeguard the correct meshing it might be possible that Meshing Check leads to a wider belt.

### FLEXION RESISTANCE

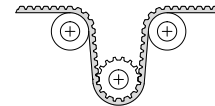
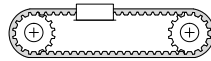

	$z_{min}$	$z_{min}$	IDLER MIN DIA (mm)
Glass cords	28	35	250

### PULLEYS

(FOR MORE DETAILS PLEASE SEE OUR PULLEY CATALOGUE)

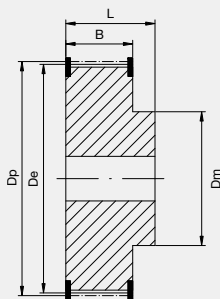

N° TEETH	DP	DE
28	124,78	121,98
30	133,69	130,90
32	142,60	139,81
34	151,52	148,73
36	160,43	157,64
38	169,34	166,55

N° TEETH	DP	DE
40	178,25	175,46
44	169,08	193,29
48	213,90	211,11
54	249,55	246,76
64	285,20	282,41

RUBBER OPEN-ENDED



# SILVER3 3M OPEN-ENDED

## SPIRAL CUT



STANDARD WIDTHS (mm)	10	15	20	25
Weight (gr/m)	25	40	52	64
Standard roll length and tolerance (m)	50 ± 5	50 ± 5	50 ± 5	50 ± 5

Standard compound:	<b>NBR</b>
Standard tooth cover:	<b>Nylon fabric</b>
Standard cord:	<b>Fiberglass</b>
Standard width tolerance:	<b>± 0,4 mm</b>
Standard thickness tolerance:	<b>± 0,25 mm</b>
Standard length tolerance:	<b>± 0,8 mm/m</b>

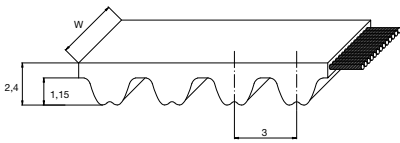

## TRACTION RESISTANCE AND ELONGATION DATA

### CALCULATION PARAMETERS

BELT WIDTH (mm)	BREAKING STRENGTH (N)
10	1930
15	3030
20	3710
25	4780

### BELT ELONGATION

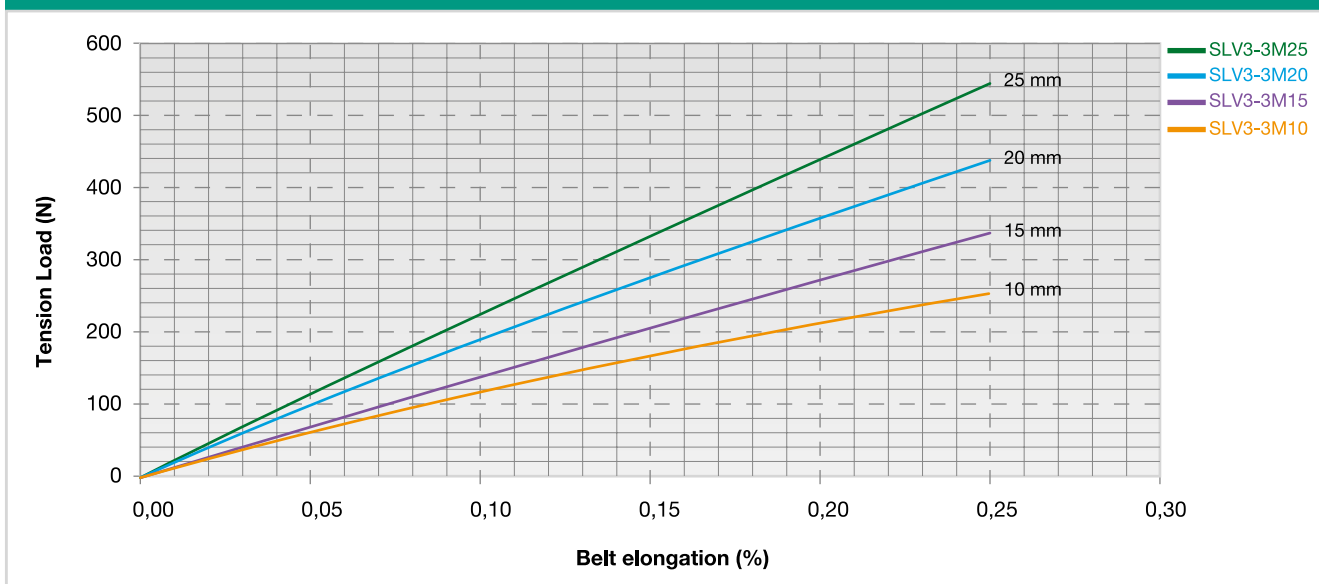

# SILVER3 3M OPEN-ENDED

## SPIRAL CUT

### FLEXION RESISTANCE

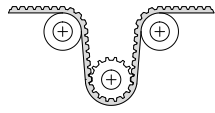
			
	$z_{min}$	$z_{min}$	IDLER MIN DIA (mm)
Fiberglass cords	10	14	30

### PULLEYS

(FOR MORE DETAILS PLEASE SEE OUR PULLEY CATALOGUE)

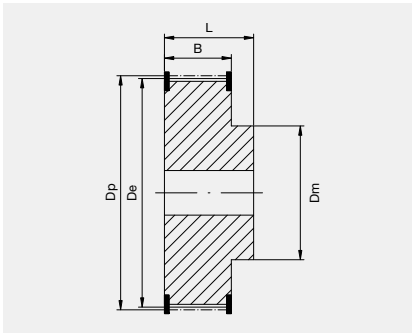

N° TEETH	DP	DE
10	9,55	8,79
12	11,46	10,70
14	13,37	12,61
16	15,28	14,52
18	17,19	16,43
20	19,10	18,34
21	20,05	19,29
22	21,01	20,25
24	22,92	22,16
26	24,83	24,07

N° TEETH	DP	DE
28	26,74	25,98
30	28,65	27,89
32	30,56	29,80
36	34,38	33,62
40	38,20	37,44
44	42,02	41,25
48	45,84	45,07
60	57,30	56,53
72	68,75	67,99

# SILVER3 5M OPEN-ENDED

## SPIRAL CUT



STANDARD WIDTHS (mm)	10	15	20	25	30
Weight (gr/m)	42	63	84	105	126
Standard roll length and tolerance (m)	50 ± 5	50 ± 5	50 ± 5	50 ± 5	50 ± 5

Standard compound: **Nitrile rubber 90 ± 4 ShA**

Standard tooth cover: **Nylon fabric**

Standard cord: **Fiberglass**

Standard width tolerance: **± 0,5 mm**

Standard thickness tolerance: **± 0,25 mm**

Standard length tolerance: **± 0,8 mm/m**

*Antistatic in standard version (according ISO 9563)*

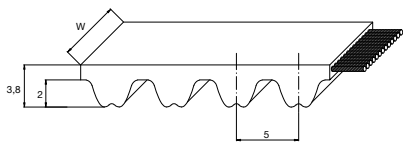

## TRACTION RESISTANCE AND ELONGATION DATA

### CALCULATION PARAMETERS

BELT WIDTH (mm)	BREAKING STRENGTH (N)
10	3900
15	5780
20	7560
25	9260
30	10.600

### BELT ELONGATION

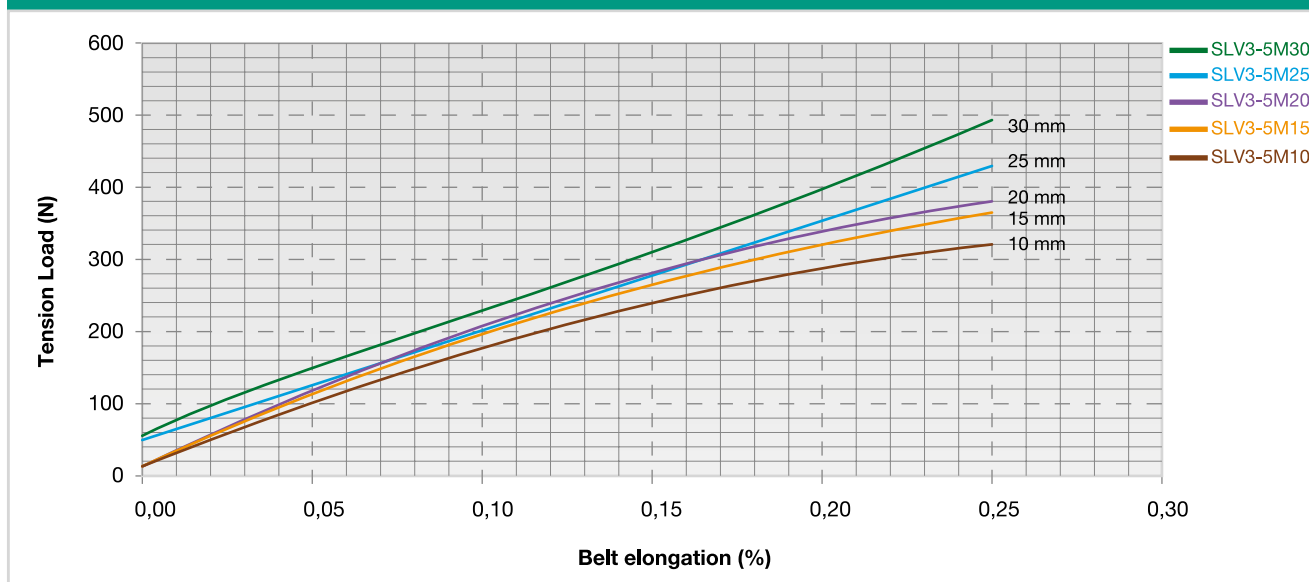

# SILVER3 5M OPEN-ENDED

## SPIRAL CUT

### FLEXION RESISTANCE

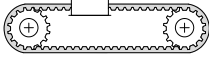
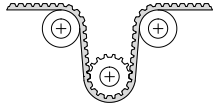
			
	$z_{min}$	$z_{min}$	<b>IDLER MIN DIA (mm)</b>
Fiberglass cords	12	16	50

### PULLEYS

(FOR MORE DETAILS PLEASE SEE OUR PULLEY CATALOGUE)

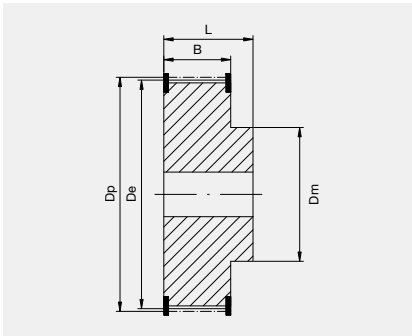

N° TEETH	DP	DE
12	19,10	17,96
14	22,28	21,14
15	23,87	22,73
16	25,46	24,32
18	28,65	27,50
20	31,83	30,69
21	33,42	32,28
22	35,01	33,87
24	38,20	37,05
26	41,38	40,24

N° TEETH	DP	DE
28	44,56	43,42
30	47,75	46,60
32	50,93	49,79
36	57,30	56,15
40	63,66	62,52
44	70,03	68,89
48	76,39	75,25
60	95,49	94,35
72	114,59	113,45

RUBBER OPEN-ENDED

# SILVER3 8M OPEN-ENDED

## SPIRAL CUT



STANDARD WIDTHS (mm)	10	15	20	25	30
Weight (gr/m)	54	81	108	135	162
Standard roll length and tolerance (m)	50 ± 5	50 ± 5	50 ± 5	50 ± 5	50 ± 5

Standard compound: **Nitrile rubber 90 ± 4 ShA**

Standard tooth cover: **Nylon fabric**

Standard cord: **Fiberglass**

Standard width tolerance: **± 0,5 mm**

Standard thickness tolerance: **± 0,40 mm**

Standard length tolerance: **± 0,8 mm/m**

*Antistatic in standard version (according ISO 9563)*

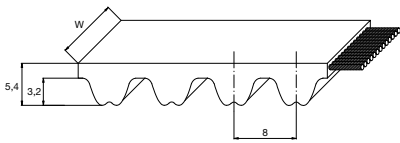

## TRACTION RESISTANCE AND ELONGATION DATA

### CALCULATION PARAMETERS

BELT WIDTH (mm)	BREAKING STRENGTH (N)
10	6110
15	9930
20	12500
25	16100
30	17600

### BELT ELONGATION

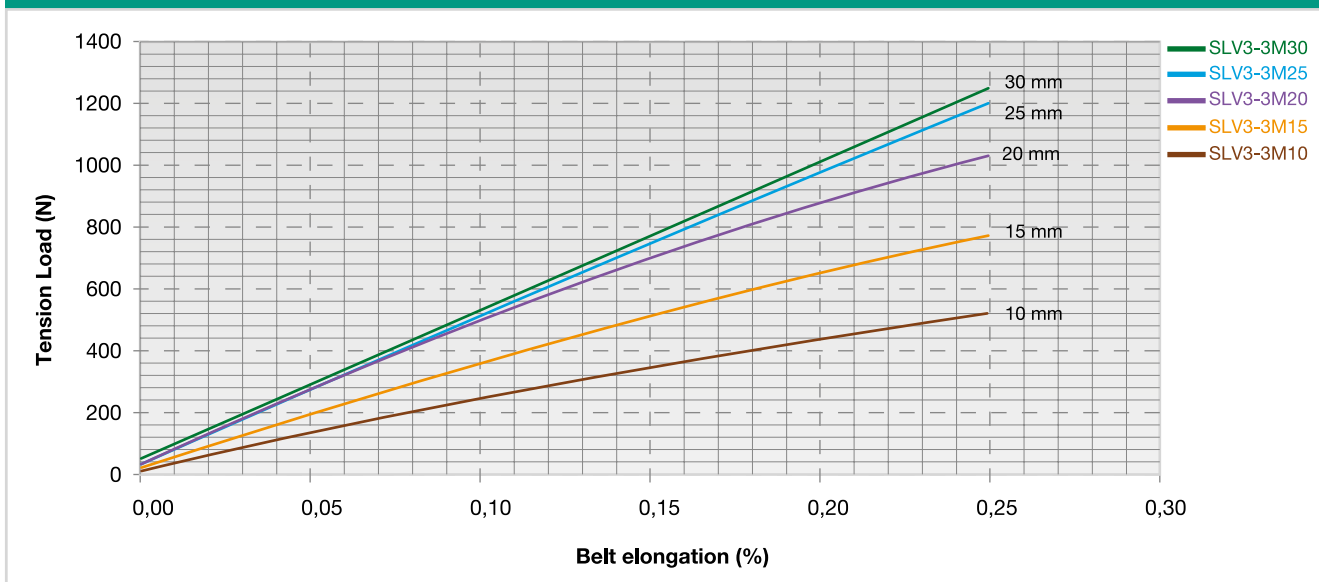

# SILVER3 8M OPEN-ENDED

## SPIRAL CUT

### FLEXION RESISTANCE

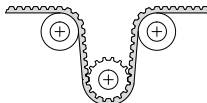
			
	$z_{min}$	$z_{min}$	<b>IDLER MIN DIA (mm)</b>
Fiberglass cords	22	22	100

### PULLEYS

(FOR MORE DETAILS PLEASE SEE OUR PULLEY CATALOGUE)

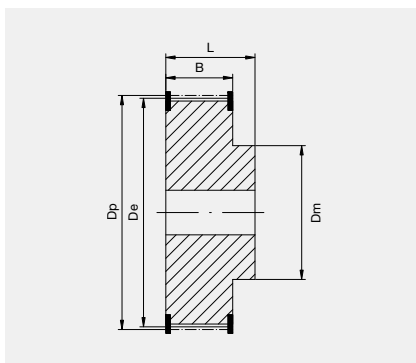

N° TEETH	DP	DE
22	56,02	54,65
24	61,12	59,74
26	66,21	64,84
28	71,30	69,93
30	76,39	75,02
32	81,49	80,12
34	86,58	85,21
36	91,67	90,30
38	96,77	95,39
40	101,86	100,49
44	112,05	110,67

N° TEETH	DP	DE
48	122,23	120,86
54	137,51	136,14
64	162,97	161,60
72	183,35	181,97
80	203,72	202,35
90	229,18	227,81
112	285,21	283,83
144	366,69	365,32
168	427,81	426,44
192	488,92	487,55

RUBBER OPEN-ENDED

# TITANIUM 8M OPEN-ENDED

## SPIRAL CUT



STANDARD WIDTHS (mm)	10	12	15	20	25	30	50
Weight (gr/m)	45	54	67	90	112	135	225
Standard roll length and tolerance (m)	50 ± 5	50 ± 5	50 ± 5	50 ± 5	50 ± 5	50 ± 5	50 ± 5

Standard compound:	<b>HNBR rubber</b>
Standard tooth cover:	<b>High performance fabric with special anti-friction treatment</b>
Standard cord:	<b>100% Carbon Fiber</b>
Standard width tolerance:	<b>± 0,5 mm</b>
Standard thickness tolerance:	<b>± 0,40 mm</b>
Standard length tolerance:	<b>± 0,8 mm/m</b>

Antistatic in standard version (according ISO 9563)

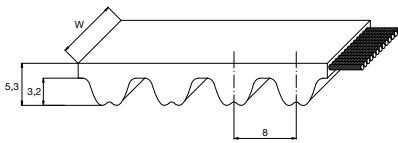

## TRACTION RESISTANCE AND ELONGATION DATA

### CALCULATION PARAMETERS

BELT WIDTH (mm)	BREAKING STRENGTH (N)
10	10400
12	12900
15	16100
20	20500
25	27900
30	31889
50	54667

### BELT ELONGATION

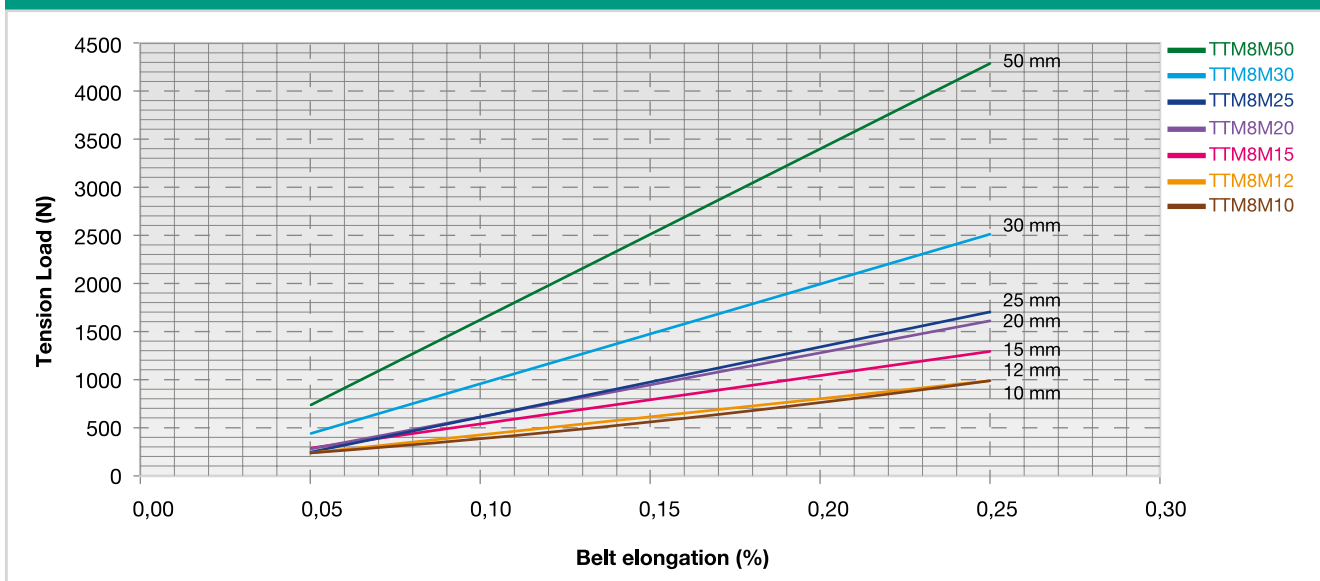

RUBBER OPEN-ENDED

# TITANIUM 8M OPEN-ENDED

## SPIRAL CUT

### FLEXION RESISTANCE

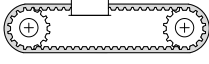
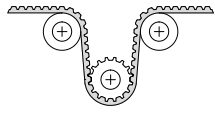
			
	$z_{min}$	$z_{min}$	<b>IDLER MIN DIA (mm)</b>
Carbon cords	22	22	100

### PULLEYS

(FOR MORE DETAILS PLEASE SEE OUR PULLEY CATALOGUE)

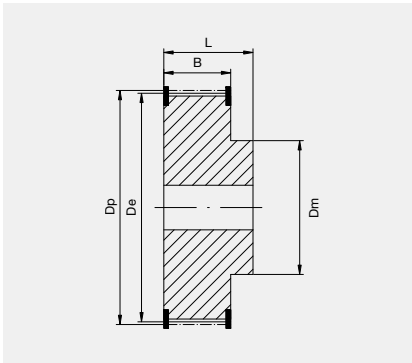

N° TEETH	DP	DE
22	56,02	54,65
24	61,12	59,74
26	66,21	64,84
28	71,30	69,93
30	76,39	75,02
32	81,49	80,12
34	86,58	85,21
36	91,67	90,30
38	96,77	95,39
40	101,86	100,49
44	112,05	110,67

N° TEETH	DP	DE
48	122,23	120,86
54	137,51	136,14
64	162,97	161,60
72	183,35	181,97
80	203,72	202,35
90	229,18	227,81
112	285,21	283,83
144	366,69	365,32
168	427,81	426,44
192	488,92	487,55

RUBBER OPEN-ENDED



# TITANIUM 14M OPEN-ENDED

## SPIRAL CUT



STANDARD WIDTHS (mm)	15	20	25	37
Weight (gr/m)	45	90	112	166
Standard roll length and tolerance (m)	50 ± 5	50 ± 5	50 ± 5	50 ± 5

Standard compound:	<b>HNBR rubber</b>
Standard tooth cover:	<b>High performance fabric with special anti-friction treatment</b>
Standard cord:	<b>100% Carbon Fiber</b>
Standard width tolerance:	<b>± 1,35 mm</b>
Standard thickness tolerance:	<b>± 0,4 mm</b>
Standard length tolerance:	<b>± 0,8 mm/m</b>

Antistatic in standard version (according ISO 9563)

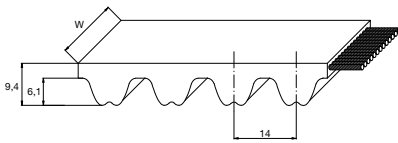

## TRACTION RESISTANCE AND ELONGATION DATA

### CALCULATION PARAMETERS

BELT WIDTH (mm)	BREAKING STRENGTH (N)
15	29165
20	36779
25	45432
37	73709

### BELT ELONGATION

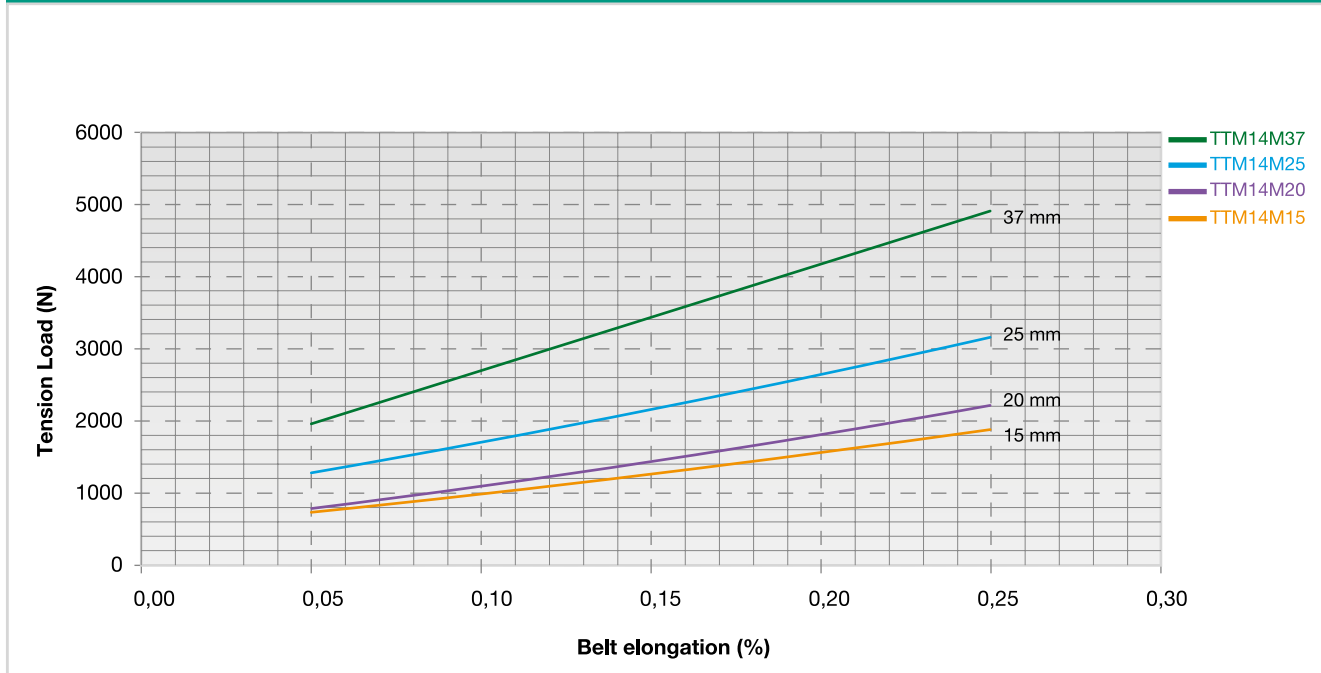

RUBBER OPEN-ENDED

# TITANIUM 14M OPEN-ENDED

## SPIRAL CUT

### FLEXION RESISTANCE

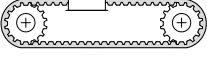
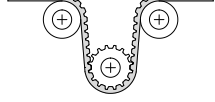
		
	<b>z<sub>min</sub></b>	<b>z<sub>min</sub></b> <b>IDLER MIN DIA (mm)</b>
Carbon cords	28	35      250

### PULLEYS

(FOR MORE DETAILS PLEASE SEE OUR PULLEY CATALOGUE)

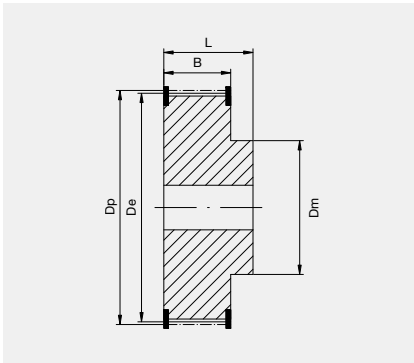

N° TEETH	DP	DE
28	124,78	121,98
30	133,69	130,90
32	142,60	139,81
34	151,52	148,73
36	160,43	157,64
38	169,34	166,55
40	178,25	175,46
44	169,08	193,29
48	213,90	211,11
54	249,55	246,76
64	285,20	282,41

# STD8 OPEN-ENDED

## SPIRAL CUT



STANDARD WIDTHS (mm)	10	12	15	20	25
Weight (gr/m)	55	66	83	110	138
Standard roll length and tolerance (m)	50 ± 5	40 ± 5	45 ± 5	50 ± 5	50 ± 5

Standard compound: **Chloroprene 74 ± 4 ShA**

Standard tooth cover: **nylon fabric**

Standard cord: **glass**

Standard width tolerance: **± 0,5 mm**

Standard thickness tolerance: **± 0,40 mm**

Standard length tolerance: **± 0,8 mm/m**

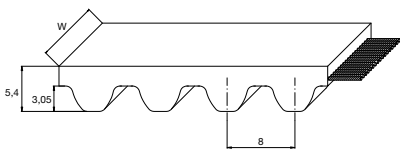

## TRACTION RESISTANCE AND ELONGATION DATA

### CALCULATION PARAMETERS

BELT WIDTH (mm)	BREAKING STRENGTH (N)
10	4200
12	5040
15	6650
20	7850
25	8690

### BELT ELONGATION

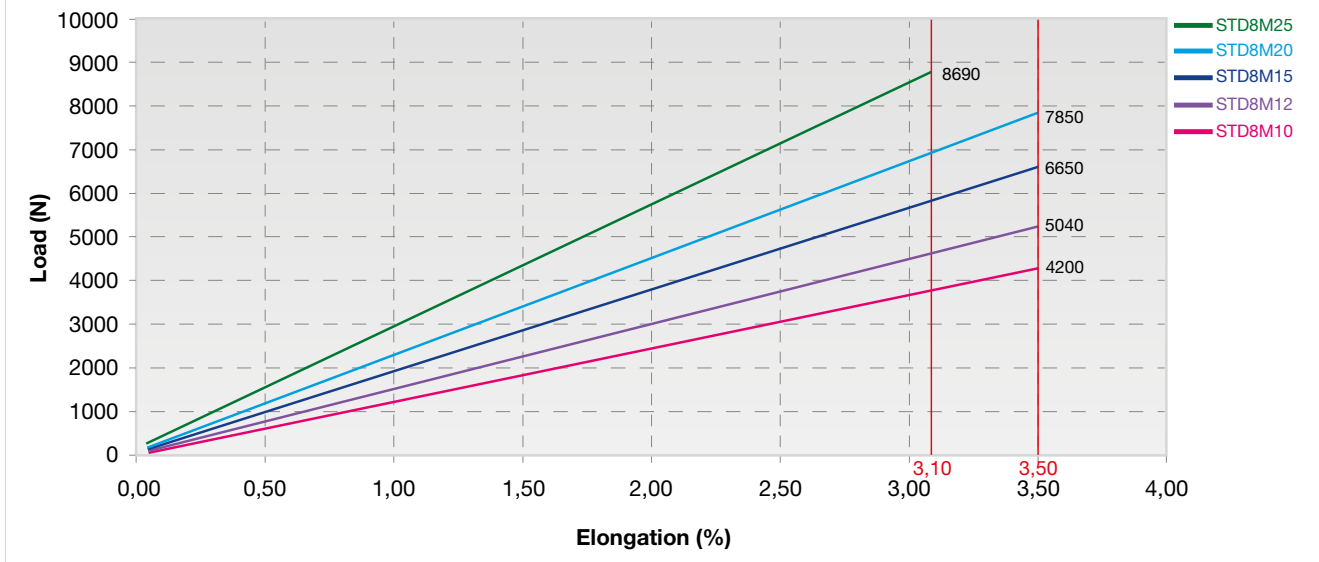

### RUBBER OPEN-ENDED

# STD8 OPEN-ENDED

## SPIRAL CUT

### TOOTH RESISTANCE

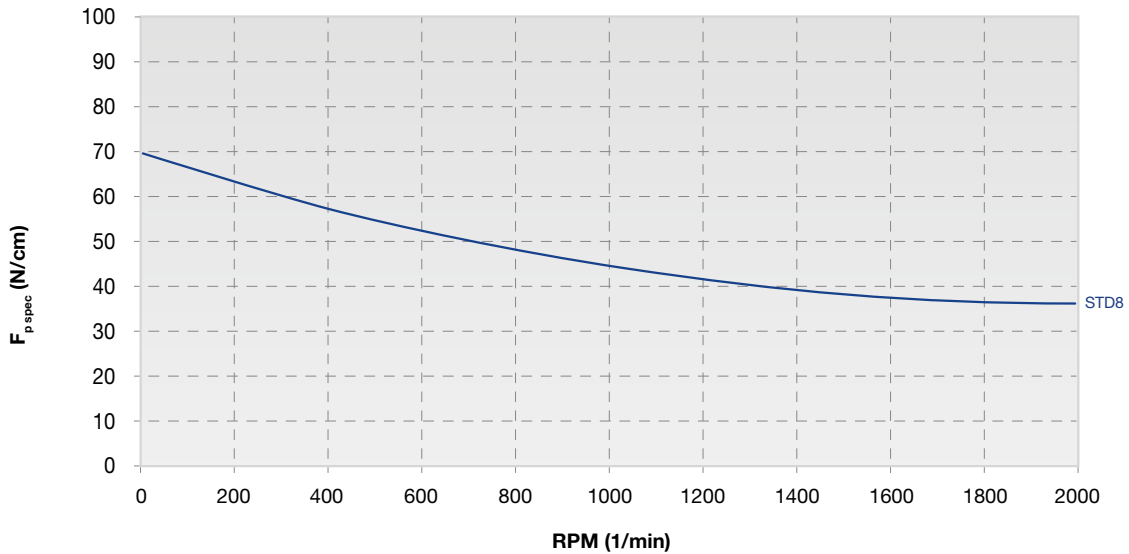

RPM (1/min)	0	10	50	100	200	500	1000	1500	2000
$F_{p\ spec}$ (N/cm)	70	69	65	63	61	54	44	38	36

Meshing Check is very suggested because of the belt's elasticity.

To safeguard the correct meshing it might be possible that Meshing Check leads to a wider belt.

### FLEXION RESISTANCE

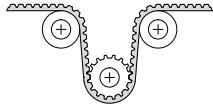
			
	$z_{min}$	$z_{min}$	IDLER MIN DIA (mm)
Glass cords	22	22	100

### PULLEYS

(FOR MORE DETAILS PLEASE SEE OUR PULLEY CATALOGUE)

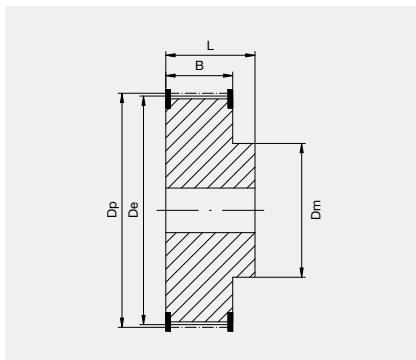

N° TEETH	DP	DE
22	56,02	54,62
24	61,12	59,72
26	66,21	64,81
28	71,30	69,90
30	76,39	74,99
32	81,49	80,09
34	86,58	85,18
36	91,67	90,27
38	96,77	95,37
40	101,86	100,46
44	112,05	110,65

N° TEETH	DP	DE
48	122,23	120,83
56	142,60	141,23
64	162,97	160,57
72	183,35	181,95
80	203,72	202,32
90	229,18	227,78
112	285,21	283,81
144	366,69	365,29
168	427,81	426,41
192	488,92	487,52

# SPECIAL EXECUTION

## FEASIBILITY

Megadyne can make special execution on customer's request to improve belt properties and to better suit special applications.

### **SUPER**

On customer's request and with minimum quantity we can produce the belt with a double nylon fabric on teeth surface to improve torque carrying capacity.

The advantages are the following:

- Increased performance by approximately 10%
- Exceptional resistance to abrasion
- Low coefficient of friction
- Increased drive efficiency
- Increased belt and pulley life

### **SPECIAL CONSTRUCTIONS**

On customer's request and with minimum quantity we can produce SILVER3 14M, GOLD2 5M, GOLD2 8M, and GOLD2 14M in open-ended version up to a width of 25 mm.

### **ANTISTATIC**

On customer's request and with minimum quantity we can produce L, H, RPP5 and RPP8 belts in antistatic version (according to BS 2050). With minimum quantity Megadyne can also produce super-conductive belts overcoming ISO 9563 parameters.

### **HIGH TEMPERATURE**

On customer's request and with minimum quantity we can produce special constructions.

### **SPECIAL BRANDING**

On customer's request and with minimum quantity we can customize the belt's branding.

### **SPECIAL PACKAGING**

On customer's request and with minimum quantity we can package the belts following some special indications.

### **SPECIAL WIDTH**

On customer's request and with minimum quantity belts in special widths can be manufactured. For more information please check with our Application Department.

### **LOW NOISE**

On customer's request and with minimum quantity we can produce soft compound belts to reduce noise problems. In this case the belt performance will decrease by approximately 10% compared to standard construction.



# CLAMPING PLATES



The clamping plates are used to fasten the ends of the open belts. On the customer's request, the plates can be delivered with or without fixing holes. As the belt can't be stretched with clamping plates installed we suggest to use other tension system. The plates are delivered in aluminium alloy.

Contact Megadyne Application Engineering staff for assistance with special or particular applications.

## ALUMINIUM

### CLAMPING PLATES FOR IMPERIAL PITCH BELTS

Pitch	F	d	B	A	S	BELT WIDTH (INCHES)							
						025	037	050	075	100	150	200	300
						C							
<b>XL*</b>	6	5,5	3,5	42,5	8	25,5	28,5	32	-	-	-	-	-
<b>L*</b>	8	9	5	76,5	15	-	-	39	45	51,5	-	-	-
<b>H*</b>	10	11	9	106,9	22	-	-	45	51	57,5	70	83	108

\*Available in customized length

## ALUMINIUM

### CLAMPING PLATES FOR HTD PITCH BELTS

Pitch	F	d	B	A	S	BELT WIDTH (MM)								
						9	10	15	20	25	30	40	50	55
						C								
<b>5M*</b>	6	5,5	3,25	41,5	8	28	-	34	-	44	-	-	-	-
<b>8M*</b>	8	9	5	66	15	-	35	40	45	-	55	-	75	-
<b>14M*</b>	10	11	9	106,9	22	-	-	-	-	56	-	71	-	86

\*Available in customized length

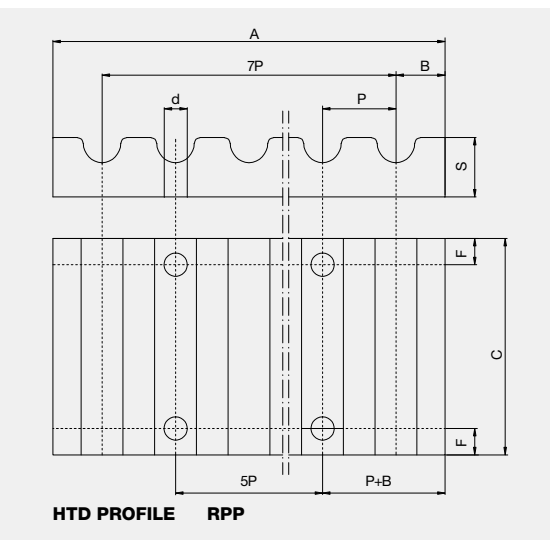
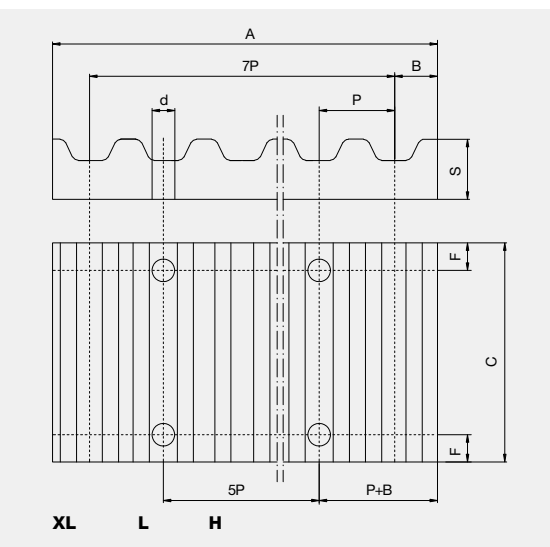

### ORDER CODE EXAMPLE:

AT10 pitch clamping plate for 25 mm width belt.



# USEFUL FORMULAS

## AND CONVERSION TABLE

### SPEED

$V = \frac{d_1 \cdot n_1}{19100}$	$n_1 = \frac{V \cdot 19100}{d_1}$	$d_1 = \frac{V \cdot 19100}{n_1}$
-----------------------------------	-----------------------------------	-----------------------------------

*V*: peripheral speed [m/s] | *n*<sub>1</sub>: rotation speed [RPM] | *d*<sub>1</sub>: pulley diameter [mm]

### FORCES AND TORQUE

$F_u = \frac{19,1 \cdot 10^6 \cdot P}{d_1 \cdot n_1}$	$F_u = \frac{2000 \cdot M}{d_1}$	$F_u = \frac{P \cdot 10^3}{d_1}$
$M_t = \frac{P \cdot 9550}{n_1}$	$M_t = \frac{F_u \cdot d_1}{2000}$	$M_t = \frac{P \cdot d_1}{2 \cdot V}$

*F*<sub>u</sub>: peripheral force [N] | *M*<sub>t</sub>: drive torque [Nm] | *P*: power [kW]  
*n*<sub>1</sub>: rotation speed [RPM] | *d*<sub>1</sub>: pulley diameter [mm] | *V*: peripheral speed [m/s]

### POWER

$P = \frac{F_u \cdot d_1 \cdot n_1}{19,1 \cdot 10^6}$	$P = \frac{M_t \cdot n_1}{9550}$	$P = \frac{F_u \cdot V}{1000}$
---	----------------------------------	--------------------------------

*P*: power [kW] | *F*<sub>u</sub>: peripheral force [N] | *M*<sub>t</sub>: drive torque [Nm]  
*n*<sub>1</sub>: rotation speed [RPM] | *d*<sub>1</sub>: pulley diameter [mm]

TO CONVERT FROM	TO	MULTIPLY BY
CV	HP	0,9863201
CV	kcal/h	63,24151
CV	W	735,4988
CV	kW	0,7354988
CV	kgf ⇔ m/s	75
CV	lbf ⇔ ft/s	542,476
HP	CV	1,01387
HP	kcal/h	641,1865
HP	W	745,6999
HP	kW	0,7456999
HP	kgf ⇔ m/s	76,04022
HP	lbf ⇔ ft/s	550
in	m	0,0254
in	cm	2,54
in	mm	25,4
in	ft	0,083
in <sup>2</sup>	m <sup>2</sup>	0,00064516
in <sup>2</sup>	cm <sup>2</sup>	6,4516
in <sup>2</sup>	mm <sup>2</sup>	645,16
in <sup>2</sup>	ft <sup>2</sup>	0,006944444
in <sup>3</sup>	m <sup>3</sup>	1,63871·10 <sup>-5</sup>
in <sup>3</sup>	cm <sup>3</sup>	16,38706
in <sup>3</sup>	mm <sup>3</sup>	16387,06
in <sup>3</sup>	ft <sup>3</sup>	0,000578704
J	CV ⇔ h	3,77673·10 <sup>-7</sup>

TO CONVERT FROM	TO	MULTIPLY BY
J	HP ⇔ h	3,72506·10 <sup>-7</sup>
J	kWh	2,77778·10 <sup>-7</sup>
kg	lb	2,204623
kgf	N	9,80665
kgf	lbf	2,204623
kgf ⇔ m/s	CV	0,01333333
kgf ⇔ m/s	W	9,80665
kgf ⇔ m/s	kW	0,00980665
kW	CV	1,359622
kW	kcal/h	859,8452
kW	W	1000
kW	kgf ⇔ m/s	101,9716
kW	lbf ⇔ ft/s	737,5621
lb	kg	0,4535924
lbf	kgf	0,4535924
lb	N	4,448222
N	kgf	0,1019716
N	lbf	0,2248089
W	CV	0,001359622
W	HP	0,001341022
W	kcal/h	0,8598452
W	kW	0,001
W	kgf ⇔ m/s	0,1019716
W	lbf ⇔ ft/s	0,7375621

# DATA SHEET

## CUSTOMER DATA

Company Name \_\_\_\_\_ Date \_\_\_\_\_

Address \_\_\_\_\_ Zip Code \_\_\_\_\_

City \_\_\_\_\_ State \_\_\_\_\_ Country \_\_\_\_\_

Customer Name/Surname \_\_\_\_\_

Office \_\_\_\_\_ Tel. \_\_\_\_\_ e-mail \_\_\_\_\_

## DRIVE INFORMATION TRANSMISSION LAYOUT

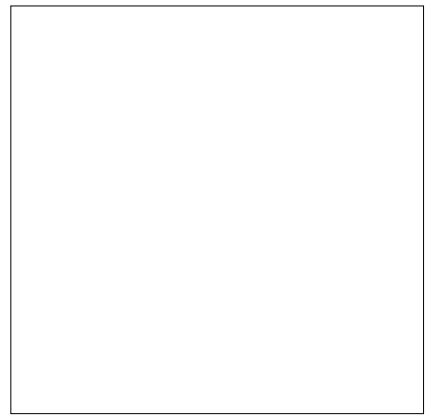
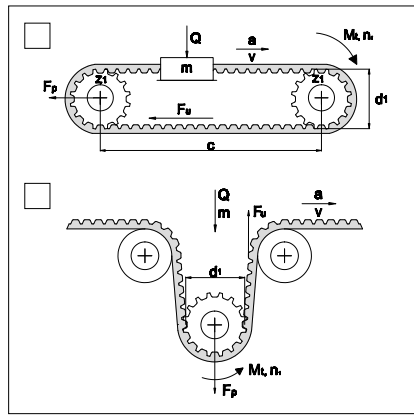
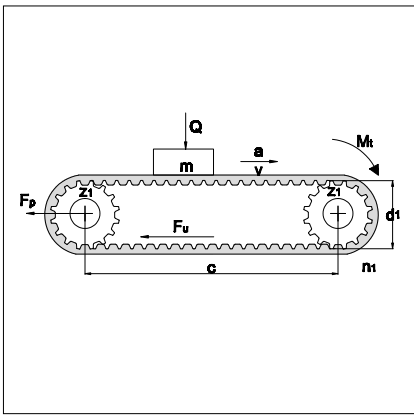

- Conveyor                       Linear motion (choose between the layout above)                       Other (If layout is different please sketch it above)

## DRIVE INFORMATION (FOR CONVEYOR)

Driver pulley's diameter \_\_\_\_\_ Driven pulley's diameter \_\_\_\_\_

Center distance \_\_\_\_\_ Minimum safety factor needed \_\_\_\_\_

Are there any size limitation?     Yes     No

(if yes, please indicate *Max diameter*, *Max width* and *Max center distance*):

Max diameter \_\_\_\_\_ Max width \_\_\_\_\_ Max center distance \_\_\_\_\_

Linear speed \_\_\_\_\_ Acceleration \_\_\_\_\_ Mass \_\_\_\_\_

Is there any sliding surface?     Yes     No                      (if yes please indicate friction coefficient): \_\_\_\_\_

Is there any cover on the back?     Yes     No                      (if yes please indicate the type) \_\_\_\_\_

Are cleats required?                       Yes     No                      (if yes please indicate cleats code, otherwise attach drawings) \_\_\_\_\_

Working time     < 8h     From 8h up to 16h     24h



# DATA SHEET

## DRIVE INFORMATION (FOR LINEAR MOTION)

Driver pulley's diameter \_\_\_\_\_ Driven pulley's diameter \_\_\_\_\_ Idler diameter \_\_\_\_\_

Center distance \_\_\_\_\_ Minimum safety factor needed \_\_\_\_\_

Are there any size limitation?  Yes  No

(if yes, please indicate *Max diameter*, *Max width* and *Max center distance*):

Max diameter \_\_\_\_\_ Max width \_\_\_\_\_ Max center distance \_\_\_\_\_

Linear speed \_\_\_\_\_ Acceleration \_\_\_\_\_ Mass \_\_\_\_\_

Working time  < 8h  From 8h up to 16h  24h

## WORK'S ENVIRONMENT INFORMATION (FOR ALL LAYOUT TRANSMISSION SYSTEM)

Work Temperature ( please indicate constant temperature and in case peaks) \_\_\_\_\_

Humidity  Standard  No standard  Other \_\_\_\_\_

Chemical agents: (oils, grass, aggressive compounds)  Yes  No

In case please indicate type and percentage \_\_\_\_\_

# NOTES

---

---

---

---

---

---

---

---

---

---

---

---

---

---

---

---

---

---

---

---

---

---

---

---

---

---

---

---

---

---

RUBBER OPEN-ENDED





# MEGADYNE

The data and information contained in the present catalogue are updated to the date of the catalogue's printing. Ammega Italia S.p.A. reserves the right to modify the specifications, performances and other information relating to the belts described in the present catalogue, at any time at its own discretion, without any prior notice.

For updating refer to our website [www.megadynegroup.com](http://www.megadynegroup.com).

Technical specifications, performances and other information provided in the present catalogue are indicative and do not bound Ammega Italia S.p.A. unless such specifications, performances or other information are expressly agreed in the agreement with the customer.

We also recommend to read carefully the following documents on our web site [www.megadynegroup.com](http://www.megadynegroup.com):

- Ammega Italia S.p.A. General Conditions of Sale (comprising the warranty)
- Theoretical Belt Life.
- Drive Components: Storage, Installation, Maintenance and Troubleshooting Handbook
- belts standard use condition and temperature.

Copyright Notice: Ammega Italia S.p.A. copyright. All rights reserved.

Ammega Italia S.p.A. is and shall remain the owner of all rights on drawings, technical specifications and any other information contained in the present catalogue or otherwise communicated by Ammega Italia S.p.A. to the customer.

The customer shall not disclose such information to third parties or use such information for purposes different from the definition of the order to Ammega Italia S.p.A., unless upon prior written authorization of Ammega Italia S.p.A.



# Discover Your Local Contacts

The local partner of choice  
for sustainable power transmission belting solutions  
around the globe.



**General contact information:**

**Megadyne**

Via Trieste, 16  
Via S. Lucia 114 - 10075 Mathi (Torino)  
Italy



Scan the QR code  
and find your local  
contact

