



**MEGADYNE**



*EN*

# **MEGAFLEX**

TECHNICAL  
HANDBOOK

# INDEX

Introduction to truly endless belts	<b>2</b>
Product range	<b>3</b>
Classifications	<b>4</b>
Technical calculation	<b>8</b>
Calculation example	<b>10</b>
Belt selection tables	<b>11</b>
Belt installation	<b>14</b>
Positioning and transmission precision	<b>16</b>
Belt data	
XL - XL DL	<b>17</b>
L - L DL	<b>18</b>
H - H DL	<b>19</b>
XH - XH DL	<b>20</b>
T5 - T5 DL	<b>21</b>
TT5	<b>22</b>
T10 - T10 DL	<b>23</b>
T20 - T20 DL	<b>24</b>
AT5 - AT5 DL	<b>25</b>
AT10 - AT10 DL	<b>26</b>
AT15	<b>27</b>
AT20 - AT20 DL	<b>28</b>
MTD8	<b>29</b>
RPP5 - RPP5 DL	<b>30</b>
RPP8 - RPP8 DL	<b>31</b>
RPP14 - RPP14 DL	<b>32</b>
P2	<b>33</b>
ATG10	<b>34</b>
Antistatic polyurethane timing belts	<b>35</b>
Measuring lengths	<b>36</b>
MEGAFLEX feasibility table	<b>37</b>
Cleats	<b>38</b>
Special execution photos	<b>51</b>
Special execution feasibility	<b>52</b>
Cover properties	<b>54</b>

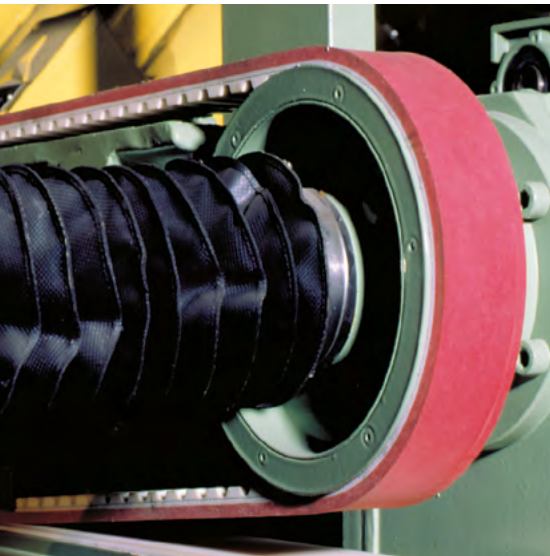

# INTRODUCTION

## TO TRULY ENDLESS BELT

Megadyne commenced manufacturing transmission belts in 1957 and extruding polyurethane endless belts in 1990. MEGAFLEX belts are manufactured in thermoplastic polyurethane, which gives superior wear and abrasion resistance. Various grades of steel cords offer good running characteristics even with high tractive load. Great production flexibility grant to designers the possibility to match any technical requirement and solution. By selecting different components and materials, MEGAFLEX belts can be manufactured to meet every customer requirement.

Megadyne has expanded the MEGAFLEX range to include:

### **MEGAFLEX FCM, MEGAFLEX XMD**

On request and with a minimum quantity, it's possible to produce MEGAFLEX FCM, made in sky blue colour (RAL 5012) and certified for direct contact with dry and wet food.

MEGAFLEX FCM can be made with a special metal and X-ray detectable compound. MEGAFLEX XMD decreases the risk of contamination from belt fragments protecting consumer' safety.

### **MEGAFLEX MEGAECO BIOBASED**

MEGAFLEX MegaEco Biobased is part of the Megadyne MegaEco range, the sustainable belt solution for power transmission systems. Made with polymer coming partially from vegetable sources, this "eco-friendly" belt can support companies to reduce their CO<sub>2</sub> footprint.



# PRODUCT RANGE

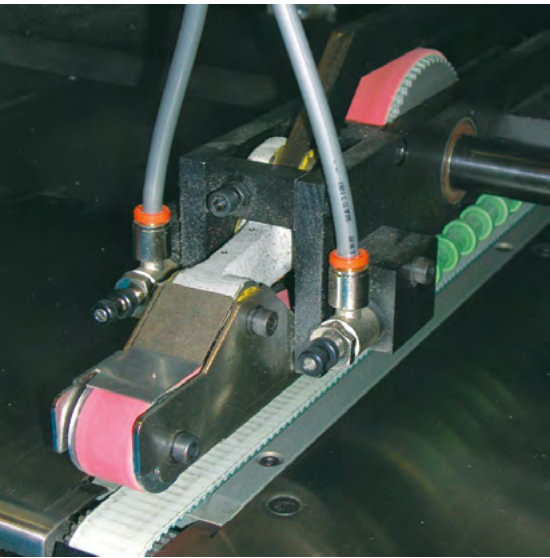

Thanks to their features, MEGAFLEX belts can be successfully used in a wide range of application such as:

- High Power Transmissions
- Ceramic industry
- Marble & Stone industry
- Glass Industry
- Painting Mixer machines
- Heavy Transport systems
- Wood industry
- Food industry

## STANDARD

## DOUBLE SIDED

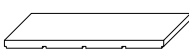
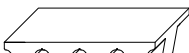
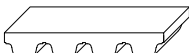
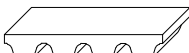
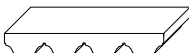
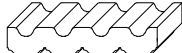
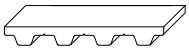
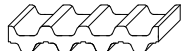
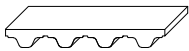

## STANDARD RANGE

XL • L • H • XH

T5 • TT5 • T10 • T20

AT5 • AT10 • AT20

AT15

RPP5 • RPP8 • RPP14

MTD8

ATG10

P2

# CLASSIFICATIONS

## CLASSIFICATIONS

MEGAFLEX timing belts are manufactured in thermoplastic polyurethane, with single helicoidal steel cords. This type of belts, developed by our Research & Development, offer good running characteristics and high-traction loads. They are especially suited for power transmissions and conveying with high loads and speeds. The addition of a nylon coating on the teeth during production enhances the running properties for specific applications and reduces the noise thanks to a lower frictional coefficient. On the back of the belt an extra thickness of special coating is also possible, offering extra protection against aggressive or heavy products.

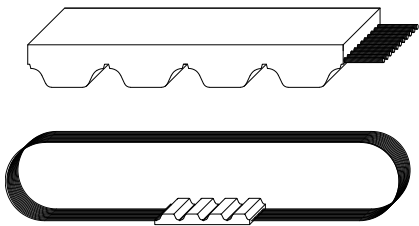

- 1.** The body of the belts is made of a white thermoplastic polyurethane 92 ShA, characterized by high levels of wear resistance even in the presence of shock and surge loading; special compound on request (see on page 49).
- 2.** High-strength helicoidal zinked steel tension members allow high-breaking load and extremely low elongation. The combination of these high-grade materials improves belt performance, which can be summarised as follows:

- exceptional resistance to abrasion and tooth shear
- low coefficient of friction
- high flexibility
- ozone and temperature resistance (-25 °C / +80 °C)
- oil, grease, and gasoline resistance.

## MECHANICAL AND CHEMICAL CHARACTERISTICS

- Constant dimensions
- Noiseless
- Free maintenance
- High flexibility
- High resistance steel traction cords, with little stretching and top flexibility
- Linear speeds up to 20 m/s
- Low pretension
- Constant length
- High abrasion resistance
- Ageing, Hydrolysis, Ozone resistant
- Working temperature -25 °C / +80 °C
- High resistance to oils, greases, and gasoline
- Fairly Acid-proof and Alkali-proof



# CLASSIFICATIONS

## MECHANICAL AND CHEMICAL CHARACTERISTICS

### **BODY**

MEGAFLEX belts are manufactured with white thermoplastic Polyurethane 92 ShA as standard.

Special compounds (different hardness, special properties) are available on request. Special compound and cords have to be tested and homologated on the application. Megadyne is not responsible for the wrong functioning of special product. Here under some PU characteristics:

### **WATER**

No problem in normal or sea clean water, at room temperature. Over 60 °C there is a fast decrement of breaking strength.

### **ACIDS**

In acid diluted proportions, at room temperature, this PU is moderately attacked. In high-concentration acid solutions, this PU has a very short lifespan. Over 50 °C, acids are always dangerous for Thermoplastic PU.

### **ALKALIS**

In alkalis diluted proportions, at room temperature, this PU is moderately attacked. In high-concentration alkaline solutions, this PU has a very short lifespan. Over 50 °C, alkalis are always dangerous for Thermoplastic PU.

### **SOLVENTS**

Thermoplastic PU is insoluble in the greater part of solvents. Only the very polar solvents (like tetrahydrofuran, dimethylformamide, n-methylpyrrolidone) can dissolve or tight damage PU. The Esters or the Ketons (such as ethyl acetate or methylethylketene) can usually produce a bulge, decreasing mechanical characteristics. Aromatic Hydrocarbons and aliphatic Hydrocarbons produce very high bulge. All effects increase by increasing temperatures.

### **OILS**

PU has a high resistance to mineral pure oils (lubricants, engine oils, combustible oils). Usually, high-performance synthetic oils, due to special additives contained, can be incompatible with Thermoplastic PU, especially at high temperatures.

### **GREASES**

PU has a high resistance to mineral pure greases (lubricating greases). Usually, high-performance synthetic greases, due to special additives contained, can be incompatible with Thermoplastic PU, especially at high temperatures.

### **FUELS**

Good resistance to petrol without alcohol. In presence of alcohol, Thermoplastic PU can suffer deterioration. Fuels, including aromatic stuff, can produce reversible bulges.

### **MICROORGANISMS**

In presence of grime, containing humidity, microorganisms can develop. In the event that microbial attack could pose a danger, you must use a special kind of PU.

### **WEATHER AGENTS**

Good resistance to atmospheric agents. White colour can change into light yellow under long UV exposure. In any case this hasn't influence on mechanical properties.



# CLASSIFICATIONS

## MECHANICAL AND CHEMICAL CHARACTERISTICS

### **CORDS**

#### **STANDARD CORD**

MEGAFLEX is manufactured with helicoidal zinked steel cords as standard.

#### **KEVLAR®**

Kevlar® tension cords are suggested in:

- Non-magnetic, for use in drives with metal detectors
- Food industry
- Applications in damp environments must be avoided

Kevlar® cord belts have a lower dimensional stability compared to steel-cord belts. Length and tolerance may change.

#### **HP**

High Performance cords have 25% more strength capacity than standard cords. They are recommended for high-repeatability applications.

#### **HF**

High Flexibility cords can accept smaller pulley and idler diameters than standard cords. They are suitable for multi-shaft drives with severe reverse bending.

#### **HPF**

High Performance and Flexibility cords have 25% more strength capacity, like the HP cords, but they are more flexible than the HP cords. They are suggested for high-performance and multi-shaft drives.

#### **STAINLESS STEEL**

Stainless steel cords have 25% less strength capacity than standard cords. They are recommended for water applications.

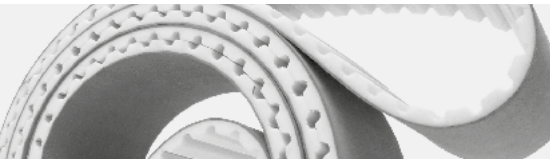

# CLASSIFICATIONS

## COATING

MEGAFLEX can be manufactured with special coating on the teeth or on the back. Please check on pages 50 and 51. Other covers on request.

## IDENTIFICATION CODE

Using the information in the table below, it is possible to identify the correct belt for every application. The code is composed of letters and numbers like in the following example:

<b>1</b>		<b>2</b>		<b>3</b>		<b>4</b>		<b>5</b>		<b>6</b>
MFX	+	50	+	AT	+	10	+	10000	+	SPECIAL MANUFACTURES

<b>1</b>	<b>MFX</b>	MEGAFLEX.
<b>2</b>	<b>50</b>	This number indicates the requested belt width. The value is in mm for a belt with pitch in mm, and in inches for a belt with pitch in inches.
<b>3</b>	<b>AT</b>	This code is composed by letters and indicates the profile.
<b>4</b>	<b>10</b>	This number indicates the standard pitch of the belt. It is expressed in mm.
<b>5</b>	<b>10000</b>	The last number indicates the length of the belt always in mm regardless of pitch.
<b>6</b>	<b>SPECIAL MANUFACTURES</b>	Special cords as Kevlar® or HP or HF or HPF or stainless steel Special compound as different hardness (85 ShA) or different colours (black - red - yellow - blue) Extra coating (NFT or AVAFC or Tenax or Linatex or Honeycomb or PU black cellulose or PU yellow or Neoprene rubber). Please see on page 50 and 51

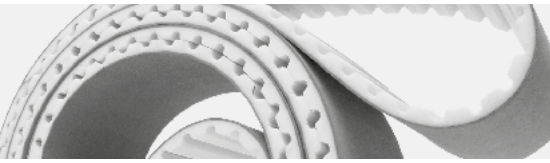

# TECHNICAL CALCULATION

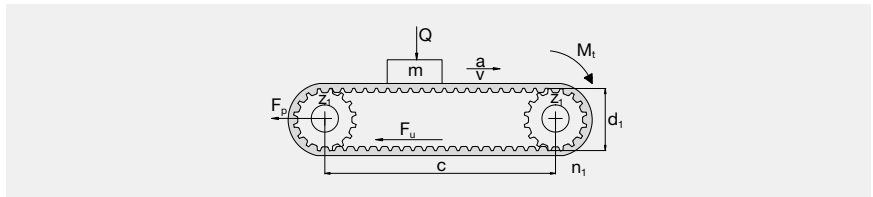
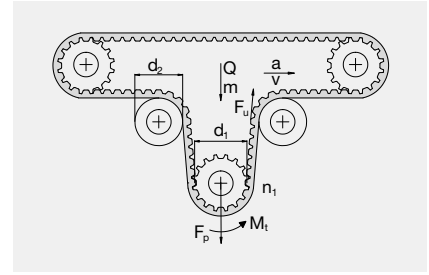
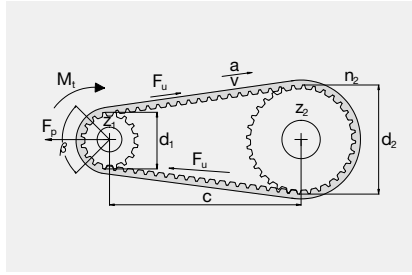

SYMBOL	UNIT	DEFINITION	SYMBOL	UNIT	DEFINITION
<b>b</b>	mm	belt width	<b>F<sub>p</sub></b>	N	pretension
<b>L</b>	mm	belt length	<b>F<sub>u</sub></b>	N	peripheral force
<b>c</b>	mm	centre distance	<b>F<sub>p spec</sub></b>	N/cm	transmittable force per tooth per unit
<b>d<sub>i</sub></b>	mm	pitch diameter of pulley i	<b>M<sub>t</sub></b>	Nm	drive torque
<b>m</b>	kg	total conveyed mass	<b>n<sub>i</sub></b>	1/min	revs/min (RPM) on pulley i
<b>a</b>	m/s <sup>2</sup>	acceleration	<b>P</b>	kW	drive power
<b>v</b>	m/s	belt speed	<b>Q</b>	N	force exerted by mass (m)
<b>C<sub>s</sub></b>	-	safety factor	<b>z<sub>i</sub></b>		number of teeth on the pulley i
<b>g</b>	m/s <sup>2</sup>	gravity (9.81)	<b>z<sub>m</sub></b>		number of teeth in mesh on the drive pulley
<b>μ</b>	-	coefficient of friction between belt and guide	<b>z<sub>s</sub></b>		number of teeth on the small pulley
<b>p</b>	-	belt pitch	<b>z<sub>L</sub></b>		number of teeth on the largest pulley
<b>MTL</b>	N	Max Traction Load	<b>BS</b>	N	Breaking Strength

Max traction load is the maximum acceptable traction on cords.  
Breaking-strength is the necessary load to break the belt's cords.

## CHOICE OF BELT PITCH, LENGTH AND PULLEY

For an optimal belt pitch see tables on page 10.

For an optimal choice of pulley size, it is desirable to have as nearest to 12 teeth in mesh as possible.

Belt length will be approximately:

$$L = 2c + 1,57 (d_1 + d_2) + \frac{(d_2 - d_1)^2}{4c}$$

Please always check available lengths in belt data pages, consider you must have an integer number of teeth.  
The actual center distance will be:

$$c = \frac{1}{4} \left[ L - \frac{p}{2} (z_1 + z_2) + \sqrt{\left[ L - \frac{p}{2} (z_1 + z_2) \right]^2 - 2 \left[ \frac{p}{\pi} (z_2 - z_1) \right]^2} \right]$$



# TECHNICAL CALCULATION

## CALCULATION OF THE PERIPHERAL FORCE ON THE TIMING BELT

<b>Knowing mass</b>	For horizontal & conveying drives <i>(Note: values of <math>\mu</math> can be found in table 3 on page 12)</i>	$F_u = (m \cdot a) + (m \cdot g \cdot \mu)$
	For vertical drives	$F_u = (m \cdot a) + (m \cdot g)$
<b>Knowing drive torque</b>	-	$F_u = 2000 M_t / d_1$
<b>Knowing drive power</b>	-	$F_u = 19,1 \cdot 10^6 \cdot P / (d_1 \cdot n_1)$

## DETERMINATION OF THE BELT WIDTH

The belt width  $b$  should be calculated using the following formula

$b = (F_u \cdot c_s \cdot 10) / (F_{p \text{ spec}} \cdot Z_m)$	<b><math>C_s</math></b>	safety factor from page 13 table number 4
	<b><math>F_u</math></b>	from above calculation
	<b><math>Z_m</math></b>	number of teeth in mesh on driver pulley <i>(nearest lower integer number)</i>
	<b><math>Z_m</math></b>	$[0,5 - \frac{4 \cdot p}{79 \cdot c} (Z_L - Z_2)] \cdot Z_s$ <i>(if calculated <math>Z_m &gt; 12</math> for an open-end application use <math>Z_m = 12</math>)</i>
	<b><math>F_{p \text{ spec}}</math></b>	transmittable force per tooth per unit width <i>(see table on belt data pages)</i>

## PRE-TENSIONING

The suggested installation tension, see on page 12.

## CORD CHECK

**ESPECIALLY FOR POWER TRANSMISSION, CHECK CAREFULLY ACCORDING TO PROCEDURE**

The maximum allowable tensile load of the belt pitch/width combination selected (see tables on belt data pages):

$$\text{max traction load of chosen belt} > \frac{F_p}{2} + (F_u \cdot C_s)$$

## SPROCKET AND IDLER DIAMETER CHECK

Ensure that all selected pulley and idler diameters are equal to, or greater than, the minimum value specified in corresponding belt data page.

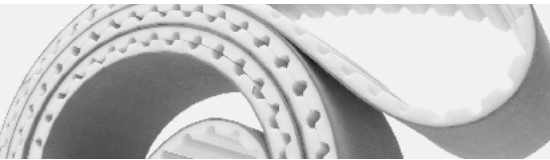

# CALCULATION EXAMPLE

## CHOICE OF BELT PITCH, LENGTH AND PULLEY

According to the belt pitch selection, table n.1 on page 11, considering the value of P and RPM, we select RPP5.

Then we consider the nearest pulley diameter to the requested value and the corresponding n. of teeth (see technical information on page 29). Therefore  $z_1 = 30$  teeth ( $d_1 = 47,75$  mm) and  $z_2 = z_1 \cdot 2 = 60$  ( $d_2 = 95,49$  mm). Belt length is  $L = 2c + 1,57 (d_1 + d_2) + [(d_2 - d_1)^2 / 4c] = 2 \cdot 900 + 1,57 \cdot (47,75 + 95,49) + (95,49 - 47,75)^2 / (4 \cdot 900) = 2025,5$  mm.

Because of this, the actual center distance will be:

$$c = \frac{1}{4} \left[ L - \frac{p}{2} (z_1 + z_2) + \sqrt{\left[ L - \frac{p}{2} (z_1 + z_2) \right]^2 - 2 \left[ \frac{p}{\pi} (z_2 - z_1) \right]^2} \right]$$

$$c = \frac{1}{4} \left[ 2025 - \frac{5}{2} (30 + 60) + \sqrt{\left[ 2025 - \frac{5}{2} (30 + 60) \right]^2 - 2 \left[ \frac{5}{\pi} (60 - 30) \right]^2} \right] = 899,68 \text{ mm}$$

## CALCULATION OF THE PERIPHERAL FORCE ON THE TIMING BELT

$$F_u = 19,1 \cdot 10^6 \cdot \frac{P}{(d_1 \cdot n_1)}$$

$$F_u = 19,1 \cdot 10^6 \cdot \frac{2}{(47,75 \cdot 1500)} = 534 \text{ N}$$

## DETERMINATION OF BELT WIDTH

$b = \frac{F_u \cdot C_s \cdot 10}{F_{p \text{ spec}} \cdot Z_m}$	$F_u$	from before (534N)
	$C_s$	from page 13 table 4, $C_s = 1,5$
$b = \frac{534 \cdot 1,5 \cdot 10}{24 \cdot 12} = 27,8 \text{ mm}$	$Z_m$	14,6 > 12 so $Z_m = 12$
	$n_1$	300 RPM (given)
	$F_{p \text{ spec}}$	24N/cm (refer on page 29 at 1500 RPM)

Since the next closest width is 30mm: 30RPP5 is chosen.

## PRE-TENSIONING

$$F_p = F_u$$

$$F_p = 534 \text{ N}$$

## CORD CHECK

**ESPECIALLY FOR POWER TRANSMISSION, CHECK CAREFULLY ACCORDING TO PROCEDURE**

From page 29 max traction load is 2100N

$$\text{max traction load} > \frac{F_p}{2} + (F_u \cdot C_2)$$

$$\frac{709}{2} + (534 \cdot 1,5) = 1155 \text{ N}$$

2100N > 1155N selected belt is acceptable.

## SPROCKET AND IDLER DIAMETER CHECK

Checking the data on page 29 for pulleys and idlers, it can be seen that the drive has an acceptable pulley diameter.

The selected belt is **30 RPP5 2025**.

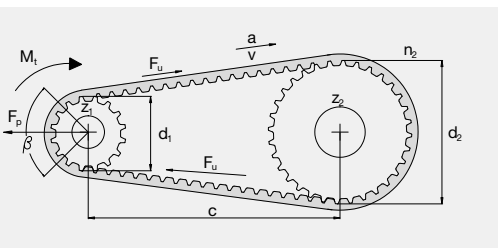

### MACHINE DATA

- P = 2kW
- Revolution = 1500 1/min
- Center distance = 900 mm
- Speed ratio (request) = 1:2
- Max radial space = 55mm in the driven pulley
- Rotary presses
- Engine type B

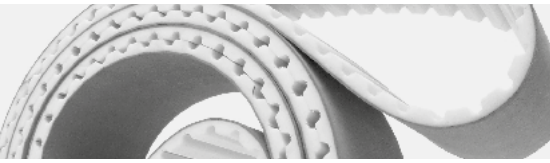

# BELT SELECTION TABLES

## BELT PITCH SELECTION

**TABLE 1**

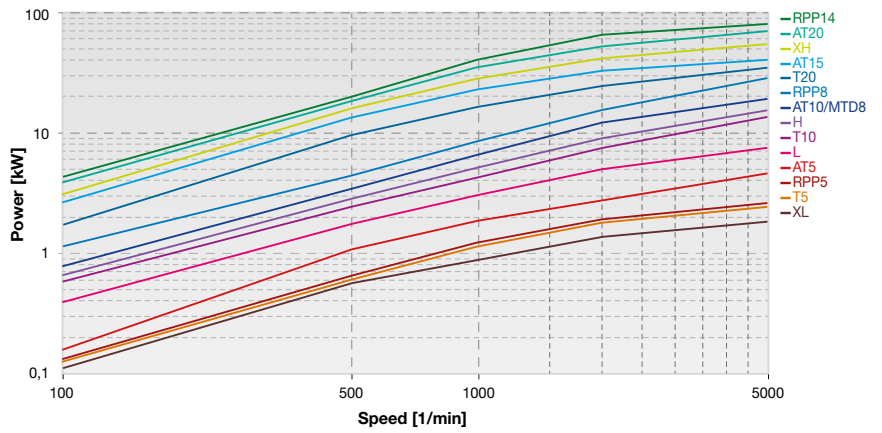

## BELT WIDTH SELECTION

**TABLE 2**

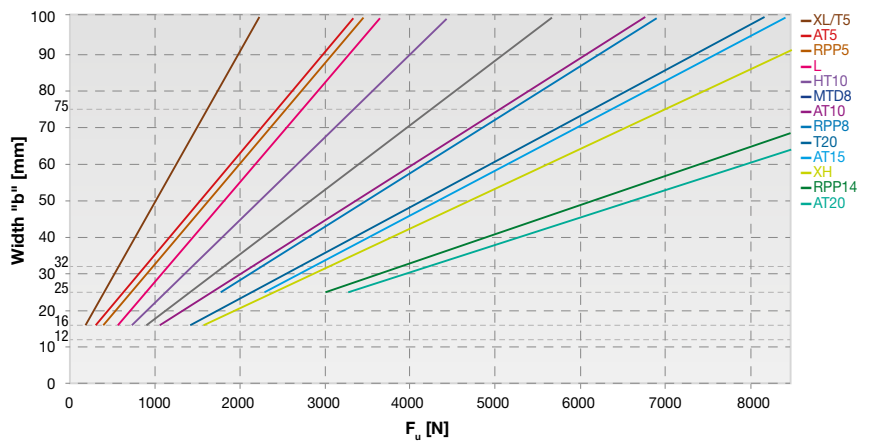



# BELT SELECTION TABLES

**TABLE 3 - FRICTION COEFFICIENT BETWEEN BELT AND GUIDE**

	Polyurethane / smooth steel	$\mu = 0,5$
	Polyurethane / rough steel	$\mu = 0,7$
	Polyurethane / abrasive steel	$\mu = 0,9$
	Polyurethane NFT / smooth steel	$\mu = 0,25$
	Polyurethane NFT / rough steel	$\mu = 0,35$
	Polyurethane NFT / abrasive steel	$\mu = 0,6$
	Polyurethane / nylon	$\mu = 0,35$
	Polyurethane NFT / nylon	$\mu = 0,15$
	Polyurethane / aluminium	$\mu = 0,8$
	Polyurethane NFT / aluminium	$\mu = 0,45$
<b>Volvent friction on dry surface</b>	Bearing	$\mu = 0,015$
	Roller / polyurethane belt	$\mu = 0,03 / 0,06$
	Bush	$\mu = 0,15$

The choice of the SAFETY FACTOR  $C_s$ , depends on the operating condition.

The following table shows the value to be used:

**TABLE 4 - SAFETY FACTOR**

<b>Driven Machine</b>	<b>Driver</b>		
	<b>Type A</b>	<b>Type B</b>	<b>Type C</b>
<b>Office machinery</b>			
Typewriters	1	1,1	1,2
Computers, printers	1,1	1,2	1,3
Teleprinters, photocopiers	1,1	1,2	1,3
Motion-picture projectors and cameras	1	1,2	1,2
<b>Domestic machinery</b>			
Centrifuges	1	1,1	1,2
Kitchen appliances, universal slicers	1,1	1,2	1,3
<b>Sewing machines</b>			
Domestic sewing machines	1,1	1,2	1,3
Industrial sewing machines	1,2	1,3	1,4
<b>Laundry machinery</b>			
Driers	1,2	1,4	1,6
Washing machines	1,4	1,6	1,8
Bakery machinery and dough mixers	1,2	1,4	1,6
<b>Conveyors</b>			
Light-duty belt conveyors	1,1	1,2	1,3
Belt conveyor for ore, coal, sand	1,2	1,4	1,6
Heavy duty conveyors	1,4	1,6	1,8
Elevators, screw conveyors	1,4	1,6	1,8
Bucket elevators	1,4	1,6	1,8
<b>Agitators</b>			
Mixers for liquids	1,2	1,4	1,6
Mixers for semi-liquids	1,3	1,5	1,7



# BELT SELECTION TABLES

**TABLE 4 - SAFETY FACTOR**

Driven Machine	Driver		
	Type A	Type B	Type C
<b>Machine tools</b>			
Lathes	1,2	1,4	1,6
Drills and grinders	1,3	1,5	1,7
Millers and planers	1,3	1,5	1,7
<b>Woodworking machinery</b>			
Lathes and band saws	1,2	1,3	1,5
Planers and disk saws	1,2	1,4	1,6
Sawmill machinery	1,4	1,6	1,8
<b>Brick machinery</b>			
Mixers	1,4	1,6	1,8
Pug mills	1,6	1,8	2
<b>Textile machinery</b>			
Spoolers and warping machines	1,2	1,4	1,6
Spinning and twisting machines	1,3	1,5	1,7
<b>Paper machinery</b>			
Agitators, calenders, driers	1,2	1,4	1,6
Pumps, beaters, pulpers	1,4	1,6	1,8
<b>Printing machinery</b>			
Linotype machines, cutters, folders	1,2	1,4	1,6
Rotary presses	1,3	1,5	1,7
<b>Screens</b>			
Drum screens	1,2	1,4	1,6
Vibrating screens	1,3	1,5	1,7
<b>Fans, Blowers</b>			
Exhauster, radial blowers	1,4	1,6	1,8
Mine ventilators, axial blowers	1,6	1,8	2
<b>Compressors</b>			
Helical compressors	1,4	1,5	1,6
Piston compressors	1,6	1,8	2
<b>Pumps</b>			
Centrifugal and gear pumps	1,2	1,4	1,6
Reciprocating pumps	1,7	1,9	2,1
Generators and exciters	1,4	1,6	1,8
Elevators and hoists	1,4	1,6	1,8
Centrifuges	1,5	1,7	1,9
Rubber machinery	1,5	1,7	1,9
<b>Mills</b>			
Hammer mills	1,5	1,7	1,9
Ball, roller and gravel mills	1,7	1,9	2,1

Type A: electric motors with low starting torque (up to 1,5 times the rated torque).

Type B: electric motors with normal starting torque (1,5 to 2,5 times the rated torque).

Type C: electric motors with high starting and breaking torque (over 2,5 times the related torque).

# BELT INSTALLATION



A major difficulty installing transmission belts is to achieve the correct belt tension. The lifetime of the support bearings and transmission belts and, therefore, the reliability of the complete system largely depend on an optimally adjusted belt tension.

Pretension is the force needed to put tension into the system to avoid the belt jumping the pulleys as in the example beside:

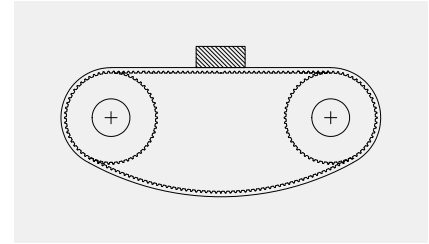

**Not correct belt installation**

For a correct system installation, all applications with the MEGAFLEX belt can be summarized according to the following cases:

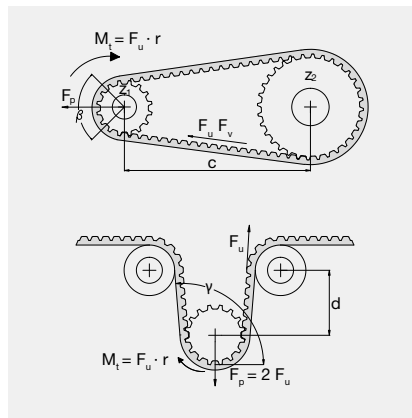

**Power transmission**

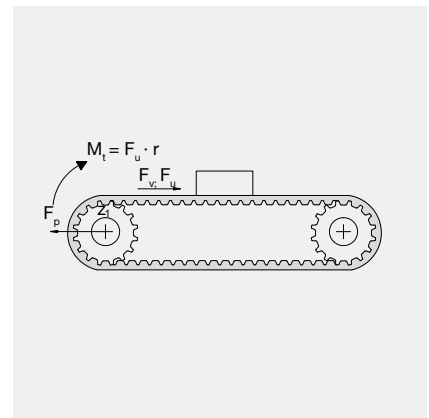

**Conveyor transmission**

In power transmission application, the pretension force is the load which has to be applied to the center of one of the driving system's pulleys in static conditions to avoid the derailing of the belt:

$$F_p = 2 \cdot F_v \cdot \sin \frac{\beta}{2}$$

$$z < 60 \quad F_v = \frac{1}{3} \cdot F_u$$

$$60 < z < 150 \quad F_v = \frac{1}{2} \cdot F_u$$

$$z > 150 \quad F_v = \frac{2}{3} \cdot F_u$$

- $z$  = belt teeth number
- $F_p$  = pretension
- $F_u$  = peripheral force
- $F_v$  = pretension on belt span
- $\beta = \pi - 2 \arcsin \left[ \frac{p(z_L - z_S)}{2 \cdot c} \right]$

For omega and conveyor transmission:  $F_p = F_u$

In omega application, to grant good mesh between the pulley and the teeth and to respect belt flexibility avoiding excessive stress on the cord, we suggest  $d = 4 \cdot$  belt width and angle  $\gamma = 120^\circ$ .



# BELT INSTALLATION

## PROCEDURE TO MEASURE

The procedure to measure the tension of the belt is to use belt tensioning equipment. This device consists of a small sensing head, which is held across the belt to be measured. The belt is then tapped to induce its vibration at its natural frequency. The vibrations are detected by the sensing head and the frequency of vibration is displayed on the measuring unit. The relation between the belt static tension ( $T_s$ ) and the frequency of vibration ( $f$ ) may be calculated using the following formula:

$$f = \frac{1}{2t} \cdot \sqrt{\frac{T_s}{m}} \quad \text{or} \quad T_s = 4 \cdot m \cdot t^2 \cdot f^2$$

### WHERE :

$T_s$ = static tension (N)	$f$ = Frequency of vibration in Hertz (Hz)
$m$ = Belt mass per unit length (kg/m)	$t$ = Free belt span length in meters (m)

For a correct system functioning and to increase the life of the belt, it is necessary a correct pulley installation: pulleys have to be parallel and aligned, as shown in drawing 1 (correct configuration). If pulleys are not parallel like in drawing 2, belt could fall during functioning and this can damage the complete equipment.

To grant a correct belt running,  $\alpha$  and  $\Delta x$  must be as small as possible. For more information, please contact our technical staff.

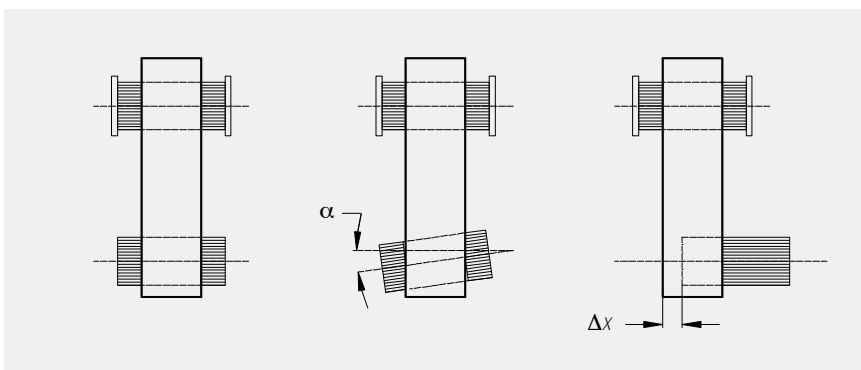

Drawing 1

Drawing 2

Drawing 3

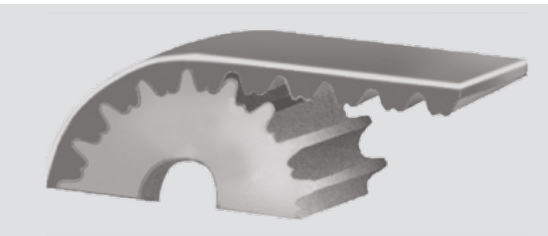

# POSITIONING

## AND TRANSMISSION PRECISION

Backlash between the belt and the pulley teeth is very important for positioning precision and transmission synchronism.

To improve transmission precision, it is possible to use zero or reduced backlash pulleys. Please note that these pulleys don't reduce the elasticity of the belt teeth or cords.

The maximum recommended pulley teeth are:

<b>Till 100</b>	1/min	Z=40
<b>Till 500</b>	1/min	Z=30
<b>Till 1000</b>	1/min	Z=20

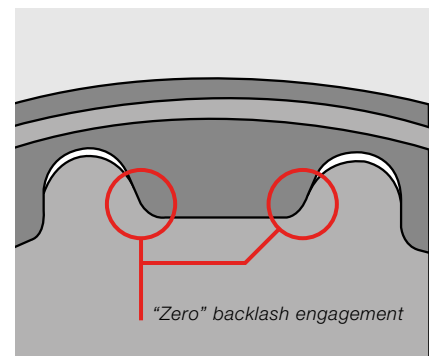
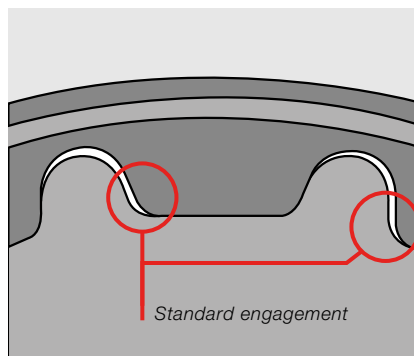

In following table, there is a list of the average values for backlashes:

AVAILABLE PITCH FOR "ZERO" BACKLASH PULLEY						
Average backlash value for standard	T5 XL	T10 L H	T20 XH	AT5	AT10	AT20
	0,6	1,2	2,4	0,2	0,4	0,8

RPP belts and pulleys offer great solutions for positioning systems because their parabolic profile reduces backlash and improves meshing quality.

# MEGAFLEX

## XL - XL DL



<b>Standard widths (inch)</b>	<b>50</b>	<b>75</b>	<b>100</b>	<b>150</b>	<b>200</b>	<b>300</b>	<b>400</b>	<b>600</b>
<b>Standard widths (mm)</b>	<b>12,7</b>	<b>19,05</b>	<b>25,4</b>	<b>38,1</b>	<b>50,8</b>	<b>76,2</b>	<b>101,6</b>	<b>152,4</b>
Weight for standard belt (gr/m)	28	42	56	85	112	170	224	340
Weight for DL belt (gr/m)	32	47	63	95	127	190	253	380

Standard compound	<b>white polyurethane thermoplastic 92ShA</b>
Standard back cover	<b>none</b>
Standard tooth cover	<b>none</b>
Standard cord	<b>zinc plated steel</b>
Standard width tolerance	<b>+/-0,5 mm</b>
Standard thickness tolerance	<b>+/-0,3 mm</b>
Standard length	<b>from 1503,68 mm (1905 mm with NFT) till 22595,84 mm</b>
Standard length tolerance	<b>See on page 36</b>
Special version belt on request	<b>See on page 37</b>

TOOTH PROFILE ACCORDING TO ISO 5296-1

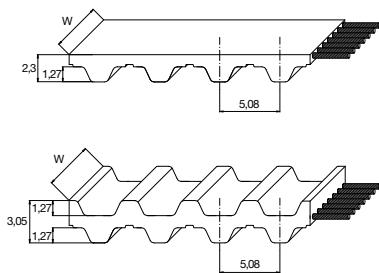

DL belt available only with standard steel, HF and stainless cord.

### TOOTH RESISTANCE

RPM (1/min)	0	20	40	60	80	100	200	300	400	500	750	1000	1500	2000	3000	4000	5000	8000
F <sub>p spec</sub> (N/cm)	19	19	18	18	17	17	16	15	15	14	13	13	12	11	10	9	8	7

### TRACTION RESISTANCE

Belt width (inch)	50		75		100		150		200		300		400		600	
	M.T.L.	B.S.	M.T.L.	B.S.	M.T.L.	B.S.	M.T.L.	B.S.	M.T.L.	B.S.	M.T.L.	B.S.	M.T.L.	B.S.	M.T.L.	B.S.
<b>Steel</b>	385	1540	620	2490	830	3325	1275	5105	1720	6885	2750	10450	4000	14010	6035	21135
<b>Kevlar®</b>	545	2195	885	3550	1180	4730	1815	7270	2450	9805	3915	14880	5700	19950	8595	30095
<b>HF</b>	505	2025	815	3270	1090	4360	1670	6695	2255	9035	3605	13710	5250	18380	7920	27730
<b>Stainless</b>	275	1110	445	1795	595	2390	915	3675	1235	4955	1980	7520	2880	10085	4345	15215

Average values in N (M.T.L. = Max Traction Load, B.S. = Breaking Strength)

### FLEXION RESISTANCE

			OUTSIDE IDLER (mm)	INSIDE IDLER (mm)
	Z <sub>min</sub>	Z <sub>minDL</sub>		
Steel	10	15	30	30
Kevlar®	10	-	30	20
HF	10	15	30	30
Stainless	13	18	35	35

### PULLEYS (FOR MORE DETAILS PLEASE SEE OUR PULLEY CATALOGUE)

	N° TEETH	DP	DE	N° TEETH	DP	DE
	10	16,17	15,66	34	54,98	54,47
12	19,40	18,89	36	58,21	57,70	
13	21,02	20,51	38	61,45	60,94	
16	25,87	25,36	40	64,68	64,17	
18	29,11	28,60	44	71,15	70,64	
20	32,34	31,83				
22	35,57	35,07				
24	38,81	38,30				
28	45,28	44,77				
30	48,51	48,00				
32	51,74	51,23				

# MEGAFLEX

## L - L DL



<b>STANDARD WIDTHS (inch)</b>	<b>50</b>	<b>75</b>	<b>100</b>	<b>150</b>	<b>200</b>	<b>300</b>	<b>400</b>	<b>600</b>
<b>STANDARD WIDTHS (mm)</b>	<b>12,7</b>	<b>19,05</b>	<b>25,4</b>	<b>38,1</b>	<b>50,8</b>	<b>76,2</b>	<b>101,6</b>	<b>152,4</b>
Weight for standard belt (gr/m)	53	71	95	143	190	285	380	570
Weight for DL belt (gr/m)	50	75	100	150	200	300	400	600

Standard compound	<b>white polyurethane thermoplastic 92ShA</b>
Standard back cover	<b>none</b>
Standard tooth cover	<b>none</b>
Standard cord	<b>zinc plated steel</b>
Standard width tolerance	<b>+/-0,5 mm</b>
Standard thickness tolerance	<b>+/-0,3 mm</b>
Standard length	<b>from 1381.125 mm (1504.95 mm with NFT ) till 22593.3 mm</b>
Standard length tolerance	<b>See on page 36</b>
Special version belt on request	<b>See on page 37</b>

DL belt available only with standard steel, HF and stainless cord.

TOOTH PROFILE ACCORDING TO ISO 5296-1

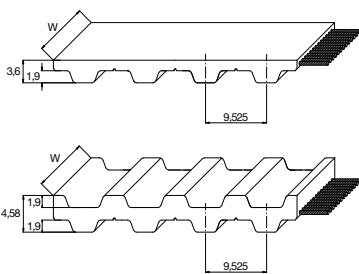

### TOOTH RESISTANCE

RPM (1/min)	0	20	40	60	80	100	200	300	400	500	750	1000	1500	2000	3000	4000	5000	8000
F <sub>p spec</sub> (N/cm)	37	36	35	35	34	33	31	29	28	27	24	23	20	19	16	15	13	11

### TRACTION RESISTANCE

Belt width (inch)	50		75		100		150		200		300		400		600	
	M.T.L.	B.S.	M.T.L.	B.S.	M.T.L.	B.S.	M.T.L.	B.S.	M.T.L.	B.S.	M.T.L.	B.S.	M.T.L.	B.S.	M.T.L.	B.S.
<b>Steel</b>	825	3305	1335	5345	1780	7125	2735	10945	3690	14765	5895	22400	8580	30040	12945	45315
<b>HF</b>	770	3085	1245	4985	1660	6650	2550	10210	3440	13775	5500	20900	8005	28025	12075	42275
<b>Stainless</b>	675	2715	1095	4385	1460	5850	2245	8985	3030	12120	4840	18390	7045	24660	10625	37200

Average values in N (M.T.L. = Max Traction Load, B.S. = Breaking Strength)

### FLEXION RESISTANCE

			OUTSIDE IDLER (mm)	INSIDE IDLER (mm)
	Z <sub>min</sub>	Z <sub>minDL</sub>		
Steel	15	20	60	60
HF	12	18	40	40
Stainless	18	22	65	65

### PULLEYS (FOR MORE DETAILS PLEASE SEE OUR PULLEY CATALOGUE)

	N° TEETH	DP	DE	N° TEETH	DP	DE
	12	36,38	35,62	36	109,15	108,39
15	45,48	44,72	40	121,28	120,52	
18	54,57	53,81	44	133,40	132,64	
20	60,64	59,88	48	145,53	144,76	
22	66,70	65,94	56	169,79	169,03	
24	72,77	72,01				
26	78,83	78,07				
28	84,89	84,13				
30	90,96	90,20				
32	97,02	96,26				
34	103,08	102,32				

# MEGAFLEX

## H - H DL



<b>Standard widths (inch)</b>	<b>50</b>	<b>75</b>	<b>100</b>	<b>150</b>	<b>200</b>	<b>300</b>	<b>400</b>	<b>600</b>
<b>Standard widths (mm)</b>	<b>12,7</b>	<b>19,05</b>	<b>25,4</b>	<b>38,1</b>	<b>50,8</b>	<b>76,2</b>	<b>101,6</b>	<b>152,4</b>
Weight for standard belt (gr/m)	61	91	122	182	243	365	487	730
Weight for DL belt (gr/m)	66	99	132	197	263	395	527	790

Standard compound	<b>white polyurethane thermoplastic 92ShA</b>
Standard back cover	<b>none</b>
Standard tooth cover	<b>none</b>
Standard cord	<b>zinc plated steel</b>
Standard width tolerance	<b>+/-0,5 mm</b>
Standard thickness tolerance	<b>+/-0,3 mm</b>
Standard length	<b>from 1384.3 mm (1551.3 mm with NFT) till 22593.3 mm</b>
Standard length tolerance	<b>See on page 36</b>
Special version belt on request	<b>See on page 37</b>

DL belt available only with standard steel, HF and stainless cord.

TOOTH PROFILE ACCORDING TO ISO 5296-1

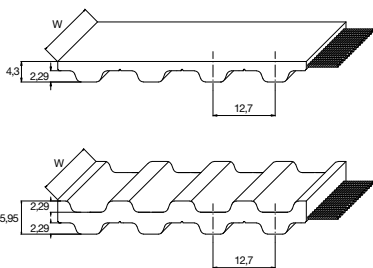

### TOOTH RESISTANCE

RPM (1/min)	0	20	40	60	80	100	200	300	400	500	750	1000	1500	2000	3000	4000	5000	8000
F <sub>p spec</sub> (N/cm)	44	43	42	41	40	39	36	34	33	31	29	27	24	22	19	17	16	12

### TRACTION RESISTANCE

Belt width (inch)	50		75		100		150		200		300		400		600	
	M.T.L.	B.S.	M.T.L.	B.S.	M.T.L.	B.S.	M.T.L.	B.S.	M.T.L.	B.S.	M.T.L.	B.S.	M.T.L.	B.S.	M.T.L.	B.S.
<b>Steel</b>	995	3990	1695	6780	2290	9175	3490	13965	4785	19150	7665	29125	11170	39100	17100	59850
<b>Kevlar®</b>	640	2565	1025	4100	1410	5640	2180	8720	3075	12310	4860	18465	6480	24620	10845	37760
<b>HF</b>	1045	4180	1775	7105	2400	9610	3655	14630	5015	20060	8030	30510	11700	40960	17910	62700
<b>Stainless</b>	805	3230	1370	5490	1855	7425	2825	11305	3875	15500	6205	23575	9040	31650	13840	48450

Average values in N (M.T.L. = Max Traction Load, B.S. = Breaking Strength)

### FLEXION RESISTANCE

			OUTSIDE IDLER (mm)	INSIDE IDLER (mm)
	Z <sub>min</sub>	Z <sub>minDL</sub>		
Steel	14	20	80	60
Kevlar®	14	-	80	60
HF	14	18	50	50
Stainless	18	24	80	65

### PULLEYS (FOR MORE DETAILS PLEASE SEE OUR PULLEY CATALOGUE)

	N° TEETH	DP	DE	N° TEETH	DP	DE
	14	56,60	55,23	40	161,70	160,33
16	64,68	63,31	44	177,87	176,50	
18	72,77	71,40	48	194,04	192,67	
20	80,85	79,48	52	210,21	208,84	
22	88,94	87,57	60	242,55	241,18	
24	97,02	95,65				
26	105,11	103,74				
28	113,19	111,82				
30	121,28	119,91				
32	129,36	127,99				
38	153,62	152,25				

# MEGAFLEX

## XH - XH DL



STANDARD WIDTHS (inch)	100	150	200	300	400	600
STANDARD WIDTHS (mm)	25,4	38,1	50,8	76,2	101,6	152,4
Weight for standard belt (gr/m)	267	400	533	800	1067	1600
Weight for DL belt (gr/m)	300	450	600	900	1200	1800

Standard compound	<b>white polyurethane thermoplastic 92ShA</b>
Standard back cover	<b>none</b>
Standard tooth cover	<b>none</b>
Standard cord	<b>zinc plated steel</b>
Standard width tolerance	<b>+/-1 mm</b>
Standard thickness tolerance	<b>+/-0,5 mm</b>
Standard length	<b>from 1511,3 mm (1911,35 mm with NFT) till 22580,60 mm</b>
Standard length tolerance	<b>See on page 36</b>
Special version belt on request	<b>See on page 37</b>

DL belt available only with standard steel, HF and stainless cord.

### TOOTH PROFILE ACCORDING TO ISO 5296-1

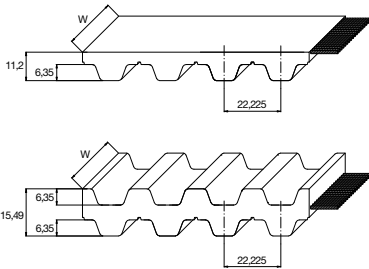

### TOOTH RESISTANCE

RPM (1/min)	0	20	40	60	80	100	200	300	400	500	750	1000	1500	2000	3000	4000	5000	8000
F <sub>p spec</sub> (N/cm)	115	111	108	105	103	101	92	86	81	78	70	65	57	51	43	37	-	-

### TRACTION RESISTANCE

Belt width (inch)	100		150		200		300		400		600	
	M.T.L.	B.S.	M.T.L.	B.S.	M.T.L.	B.S.	M.T.L.	B.S.	M.T.L.	B.S.	M.T.L.	B.S.
<b>Steel</b>	3155	12635	5185	20755	7220	28880	11400	43320	16760	58660	25525	89345
<b>HF</b>	3520	14095	5790	23160	8055	32220	12720	48335	18700	65455	28480	99690
<b>Stainless</b>	2510	10040	4120	16495	5735	22950	9060	34425	13320	46620	20285	71005

Average values in N (M.T.L. = Max Traction Load, B.S. = Breaking Strength)

### FLEXION RESISTANCE

			OUTSIDE IDLER (mm)	INSIDE IDLER (mm)
	Z <sub>min</sub>	Z <sub>minDL</sub>		
Steel	18	25	180	150
HF	18	22	120	120
Stainless	24	28	180	165

### PULLEYS (FOR MORE DETAILS PLEASE SEE OUR PULLEY CATALOGUE)

	N° TEETH	DP	DE	N° TEETH	DP	DE
	18	127,34	124,55	60	424,47	421,68
20	141,49	138,70	72	509,36	506,57	
22	155,64	152,83	84	594,25	591,46	
24	169,79	167,00	96	679,15	676,35	
26	183,92	181,13	120	848,93	846,14	
28	198,08	195,29				
30	212,23	209,44				
32	226,38	223,59				
40	282,98	280,19				
44	311,28	308,48				
48	339,57	336,78				



# MEGAFLEX

## T5 - T5 DL

Standard widths (mm)	10	16	25	32	50	75	100	150
Weight for standard belt (gr/m)	24	38	59	88	118	177	237	355
Weight for DL belt (gr/m)	27	44	68	87	137	205	274	410

Standard compound	<b>white polyurethane thermoplastic 92ShA</b>
Standard back cover	<b>none</b>
Standard tooth cover	<b>none</b>
Standard cord	<b>zinc plated steel</b>
Standard width tolerance	<b>+/-0,5 mm</b>
Standard thickness tolerance	<b>+/-0,15 mm</b>
Standard length	<b>from 1380 mm (1500 mm with NFT) till 22600 mm</b>
Standard length tolerance	<b>See on page 36</b>
Special version belt on request	<b>See on page 37</b>

### TOOTH PROFILE ACCORDING DIN 7721-1

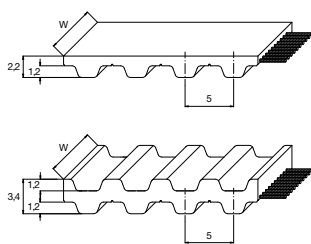

DL belt available only with standard steel, HF and standard stainless cord.

### TOOTH RESISTANCE

RPM (1/min)	0	20	40	60	80	100	200	300	400	500	750	1000	1500	2000	3000	4000	5000	8000
F <sub>p spec</sub> (N/cm)	24	23	23	22	22	22	20	19	19	18	17	16	15	14	12	11	11	9

### TRACTION RESISTANCE

Belt width (mm)	10		16		25		32		50		75		100		150	
	M.T.L.	B.S.	M.T.L.	B.S.	M.T.L.	B.S.	M.T.L.	B.S.	M.T.L.	B.S.	M.T.L.	B.S.	M.T.L.	B.S.	M.T.L.	B.S.
<b>Steel</b>	265	1065	475	1900	800	3205	1035	4155	1660	6650	2685	10210	3590	13655	5900	20660
<b>Kevlar®</b>	595	2390	1060	4255	1795	7180	2325	9310	3720	14895	6020	22875	8050	30590	13220	46280
<b>HP</b>	415	1665	740	2960	1250	5000	1620	6480	2590	10370	4190	15930	5605	21300	9205	32230
<b>HF</b>	350	1400	620	2490	1050	4205	1360	5450	2180	8720	3525	13395	4715	17915	7745	27105
<b>HPF</b>	530	2135	950	3800	1600	6410	2075	8310	3325	13300	5375	20425	7185	27310	11805	41325
<b>Stainless</b>	190	765	340	1365	575	2305	745	2990	1195	4785	1935	7353	2585	9830	4250	14875
<b>HP stainless</b>	470	1880	835	3340	1410	5640	1825	7315	2925	11700	4490	17970	6005	24035	9090	36365

Average values in N (M.T.L. = Max Traction Load, B.S. = Breaking Strength)

### FLEXION RESISTANCE

	Z <sub>min</sub>		OUTSIDE IDLER (mm)	INSIDE IDLER (mm)
	Z <sub>min</sub>	Z <sub>minDL</sub>		
Steel	10	15	30	30
Kevlar®	12	-	30	30
HP	15	-	40	60
HF	10	15	30	30
HPF	12	-	40	40
Stainless	15	20	40	40
HP stainless	18	-	65	60

### PULLEYS (FOR MORE DETAILS PLEASE SEE OUR PULLEY CATALOGUE)

N° TEETH	DP	DE	N° TEETH	DP	DE
12	19,10	18,27	40	63,66	62,93
14	22,28	21,45	44	70,03	69,20
15	23,87	23,04	48	76,39	75,57
16	25,46	24,64	60	95,49	94,67
18	28,65	27,82			
20	31,83	31,00			
24	38,20	37,37			
28	44,56	43,73			
30	47,75	46,92			
32	50,93	50,10			

# MEGAFLEX

## TT5



<b>Standard widths (mm)</b>	<b>10</b>
Weight for standard belt (gr/m)	20

Standard compound	<b>blue polyurethane thermoplastic 88 ShA</b>
Standard back cover	<b>none</b>
Standard tooth cover	<b>none</b>
Standard cord	<b>S and Z torsion aramide cord</b>
Standard width tolerance	<b>+/-0,5 mm</b>
Standard thickness	<b>3,00 -0,1/+0 mm</b>
Standard length	<b>from 1600 mm till 13950 mm</b>

TOOTH PROFILE ACCORDING DIN 7721-1

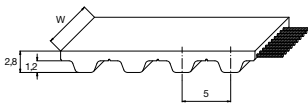

### TOOTH RESISTANCE

RPM (1/min)	0	20	40	60	80	100	200	300	400	500	750	1000	1500	2000	3000	4000	5000	8000
F <sub>p spec</sub> (N/cm)	24	23	23	22	22	22	20	19	19	18	17	16	15	14	12	11	11	9

### FLEXION RESISTANCE

	<b>Z<sub>min</sub></b>	<b>Z<sub>minDL</sub></b>	<b>OUTSIDE IDLER (mm)</b>	<b>INSIDE IDLER (mm)</b>
Aramide	12	-	30	30

### TRACTION RESISTANCE

<b>Belt width (mm)</b>	<b>10</b>	
	<b>M.T.L.</b>	<b>B.S.</b>
<b>Aramide</b>	795	3190

Elongation at M.T.L. (mm/n) = 8.  
Average values in N (M.T.L. = Max Traction Load, B.S. = Breaking Strength)





# MEGAFLEX

## T10 - T10 DL

Standard widths (mm)	12	16	25	32	50	75	100	150
Weight for standard belt (gr/m)	60	80	125	160	250	375	500	750
Weight for DL belt (gr/m)	70	94	147	188	293	440	586	880

Standard compound	<b>white polyurethane thermoplastic 92ShA</b>
Standard back cover	<b>none</b>
Standard tooth cover	<b>none</b>
Standard cord	<b>zinc plated steel</b>
Standard width tolerance	<b>+/-0,5 mm</b>
Standard thickness tolerance	<b>+/-0,3 mm</b>
Standard length	<b>from 1380 mm (1500 mm with NFT) till 22600 mm</b>
Standard length tolerance	<b>See on page 36</b>
Special version belt on request	<b>See on page 37</b>

### TOOTH PROFILE ACCORDING DIN 7721-1

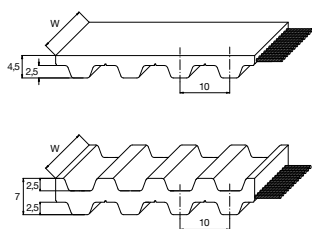

DL belt available only with standard steel, HF and standard stainless cord.

### TOOTH RESISTANCE

RPM (1/min)	0	20	40	60	80	100	200	300	400	500	750	1000	1500	2000	3000	4000	5000	8000
F <sub>p spec.</sub> (N/cm)	51	49	48	47	46	45	41	39	37	36	33	31	28	25	22	20	18	14

### TRACTION RESISTANCE

Belt width (mm)	12		16		25		32		50		75		100		150	
	M.T.L.	B.S.	M.T.L.	B.S.	M.T.L.	B.S.	M.T.L.	B.S.	M.T.L.	B.S.	M.T.L.	B.S.	M.T.L.	B.S.	M.T.L.	B.S.
<b>Steel</b>	995	3990	1395	5585	2290	9175	2990	11970	4785	19150	7665	29125	10290	39100	16870	59050
<b>Kevlar®</b>	765	3075	1025	4100	1795	7180	2435	9745	3975	15900	6480	24620	8640	32830	14510	50785
<b>HP</b>	1350	5415	1805	7220	3155	12635	4285	17145	6990	27975	11400	43320	15200	57760	25525	89345
<b>HF</b>	1045	4180	1460	5850	2400	9610	3135	12540	5015	20060	8030	30510	10780	40960	17675	61860
<b>HPF</b>	1510	6040	2010	8055	3520	14095	4780	19130	7800	31215	12720	48335	16960	64445	28480	99690
<b>Stainless</b>	805	3230	1130	4520	1855	7425	2420	9690	3875	15500	6205	23575	8330	31650	13655	47800
<b>HP stainless</b>	1075	4300	1430	5735	2510	10040	3405	13625	5555	22230	9060	34425	12080	45900	20285	71005

Average values in N (M.T.L. = Max Traction Load, B.S. = Breaking Strength)

### FLEXION RESISTANCE

	Z		Z <sub>minDL</sub>	
	Z <sub>min</sub>	Z <sub>max</sub>	OUTSIDE IDLER (mm)	INSIDE IDLER (mm)
Steel	12	20	60	60
Kevlar®	15	-	60	60
HP	15	-	100	100
HF	12	20	50	50
HPF	14	-	80	80
Stainless	15	24	70	70
HP stainless	20	-	150	150

### PULLEYS (FOR MORE DETAILS, PLEASE SEE OUR PULLEY CATALOGUE)

N° TEETH	DP	DE	N° TEETH	DP	DE
12	38,20	36,35	36	114,59	112,74
14	44,56	42,71	40	127,32	125,48
15	47,75	45,90	44	140,06	138,21
16	50,93	49,08	48	152,79	150,94
18	57,30	55,45	60	190,99	189,14
20	63,66	61,81			
24	76,39	74,55			
26	82,76	80,91			
28	89,13	87,28			
30	95,49	93,65			
32	101,86	100,01			



# MEGAFLEX

## T20 - T20 DL

Standard widths (mm)	25	32	50	75	100	150
Weight for standard belt (gr/m)	200	256	400	600	800	1200
Weight for DL belt (gr/m)	250	320	500	750	1000	1500

Standard compound	<b>white polyurethane thermoplastic 92ShA</b>
Standard back cover	<b>none</b>
Standard tooth cover	<b>none</b>
Standard cord	<b>zinc plated steel</b>
Standard width tolerance	<b>+/- 1 mm</b>
Standard thickness tolerance	<b>+/-0,45 mm</b>
Standard length	<b>from 1500 mm (1900 mm with NFT) till 22600 mm</b>
Standard length tolerance	<b>See page on 36</b>
Special version belt on request	<b>See page on 37</b>

DL belt available only with standard steel, HF and standard stainless cord.

TOOTH PROFILE ACCORDING DIN 7721-1

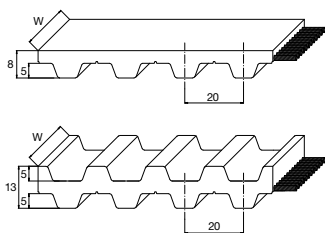

### TOOTH RESISTANCE

RPM (1/min)	0	20	40	60	80	100	200	300	400	500	750	1000	1500	2000	3000	4000	5000	8000
F <sub>p spec</sub> (N/cm)	102	98	95	93	91	89	81	76	72	68	62	57	50	45	38	33	29	-

### TRACTION RESISTANCE

Belt width (mm)	25		32		50		75		100		150	
	M.T.L.	B.S.	M.T.L.	B.S.	M.T.L.	B.S.	M.T.L.	B.S.	M.T.L.	B.S.	M.T.L.	B.S.
<b>Steel</b>	3155	12635	4285	17145	6990	27975	11400	43320	15200	57760	25525	89345
<b>Kevlar®</b>	2035	8150	2775	11115	4630	18525	7605	28895	10335	39270	17145	60020
<b>HP</b>	4515	18075	6160	24650	10270	41085	16865	64095	22920	87105	38035	133120
<b>HF</b>	3520	14095	4780	19130	7800	31215	12720	48335	16960	64445	28480	99690
<b>HPF</b>	5025	20115	6855	27430	11425	45715	18765	71320	25505	96920	42320	148125
<b>Stainless</b>	2510	10040	3405	13625	5555	22230	9060	34425	12080	45900	20285	71005
<b>HP stainless</b>	3840	15360	5235	20945	8725	34910	14330	54460	19475	74010	32315	113115

Average values in N (M.T.L. = Max Traction Load, B.S. = Breaking Strength)

### FLEXION RESISTANCE

	Z <sub>min</sub>		OUTSIDE IDLER (mm)	INSIDE IDLER (mm)
	Z <sub>min</sub>	Z <sub>minDL</sub>		
Steel	15	25	120	120
Kevlar®	15	-	120	120
HP	20	-	150	150
HF	15	25	120	120
HPF	18	-	120	120
Stainless	20	28	130	130
HP stainless	24	-	160	160

### PULLEYS (FOR MORE DETAILS, PLEASE SEE OUR PULLEY CATALOGUE)

N° TEETH	DP	DE
15	95,49	92,69
18	114,59	111,73
20	127,32	124,47
22	140,06	137,20
24	152,79	149,93
25	159,15	156,30
30	190,99	188,13
32	203,72	200,86
36	229,18	226,33
40	254,65	251,80
48	305,58	302,73
60	381,97	379,12



# MEGAFLEX

## AT5 - AT5 DL

Standard widths (mm)	10	16	25	32	50	75	100	150
Weight for standard belt (gr/m)	37	59	92	117	183	275	367	550
Weight for DL belt (gr/m)	43	68	107	137	213	320	427	640

Standard compound	<b>white polyurethane thermoplastic 92ShA</b>
Standard back cover	<b>none</b>
Standard tooth cover	<b>none</b>
Standard cord	<b>zinc plated steel</b>
Standard width tolerance	<b>+/-0,5 mm</b>
Standard thickness tolerance	<b>+/-0,2 mm</b>
Standard length	<b>from 1380 mm (1500 mm with NFT) till 22600 mm</b>
Standard length tolerance	<b>See on page 36</b>
Special version belt on request	<b>See on page 37</b>

TOOTH PROFILE ACCORDING ISO 17396

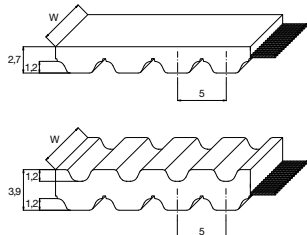

DL belt available only with standard steel, HF and standard stainless cord.

### TOOTH RESISTANCE

RPM (1/min)	0	20	40	60	80	100	200	300	400	500	750	1000	1500	2000	3000	4000	5000	8000
F <sub>p spec</sub> (N/cm)	35	35	35	34	34	34	32	31	30	29	27	26	24	22	19	18	16	13

### TRACTION RESISTANCE

Belt width (mm)	10		16		25		32		50		75		100		150	
	M.T.L.	B.S.	M.T.L.	B.S.	M.T.L.	B.S.	M.T.L.	B.S.	M.T.L.	B.S.	M.T.L.	B.S.	M.T.L.	B.S.	M.T.L.	B.S.
<b>Steel</b>	570	2290	1015	4070	1715	6870	2225	8910	3560	14255	5760	21895	7705	29275	12655	44300
<b>Kevlar®</b>	640	2565	1280	5130	2180	8720	2820	11285	4615	18465	7425	28215	9990	37960	16560	57965
<b>HP</b>	495	1995	995	3990	1695	6780	2195	8775	3590	14360	5775	21945	7770	29525	12880	45085
<b>HF</b>	530	2135	950	3800	1600	6410	2075	8310	3325	13300	5375	20425	7185	27310	11805	41325
<b>HPF</b>	520	2090	1045	4180	1775	7105	2295	9195	3760	15045	6050	22990	8140	30930	13495	47230
<b>Stainless</b>	470	1880	835	3340	1410	5640	1825	7310	2925	11700	4730	17970	6325	24035	10390	36365
<b>HP stainless</b>	400	1615	805	3230	1370	5490	1775	7105	2905	11625	4675	17765	6290	23900	10425	36495

Average values in N (M.T.L. = Max Traction Load, B.S. = Breaking Strength)

### FLEXION RESISTANCE

	Z <sub>min</sub>		OUTSIDE IDLER (mm)	INSIDE IDLER (mm)
	Z <sub>min</sub>	Z <sub>minDL</sub>		
Steel	15	18	60	25
Kevlar®	15	-	60	25
HP	25	-	80	80
HF	12	15	40	25
HPF	20	-	70	70
Stainless	18	22	65	60
HP stainless	25	-	80	80

### PULLEYS (FOR MORE DETAILS, PLEASE SEE OUR PULLEY CATALOGUE)

N° TEETH	DP	DE	N° TEETH	DP	DE
15	23,87	22,64	42	66,85	65,62
16	25,46	24,24	44	70,03	68,80
18	28,65	27,42	48	76,39	75,17
20	31,83	30,60	60	95,49	94,27
22	35,01	33,79			
24	38,20	36,97			
25	39,79	38,56			
28	44,56	43,33			
32	50,93	49,70			
36	57,30	56,07			



# MEGAFLEX

## AT10 - AT10 DL

Standard widths (mm)	12	16	25	32	50	75	100	150
Weight for standard belt (gr/m)	72	97	150	190	300	450	600	900
Weight for DL belt (gr/m)	94	117	195	234	390	585	780	1170

Standard compound	<b>white polyurethan thermoplastic 92ShA</b>
Standard back cover	<b>none</b>
Standard tooth cover	<b>none</b>
Standard cord	<b>zinc plated steel</b>
Standard width tolerance	<b>+/-0,5 mm</b>
Standard thickness tolerance	<b>+/-0,3 mm</b>
Standard length	<b>from 1380 mm (1500 mm with NFT) till 22600 mm</b>
Standard length tolerance	<b>See on page 36</b>
Standard length tolerance for HP, HPF, HP stainless, Kevlar®	<b>+0/-1 mm/m</b>
Special version belt on request	<b>See on page 37</b>

DL belt available only with standard steel, HF and standard stainless cord.

### TOOTH PROFILE ACCORDING ISO 17396

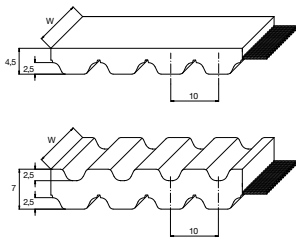

### TOOTH RESISTANCE

RPM (1/min)	0	20	40	60	80	100	200	300	400	500	750	1000	1500	2000	3000	4000	5000	8000
F <sub>p spec</sub> (N/cm)	74	72	71	71	70	69	65	62	60	58	53	50	44	40	35	30	27	20

### TRACTION RESISTANCE

Belt width (mm)	12		16		25		32		50		75		100		150	
	M.T.L.	B.S.	M.T.L.	B.S.	M.T.L.	B.S.	M.T.L.	B.S.	M.T.L.	B.S.	M.T.L.	B.S.	M.T.L.	B.S.	M.T.L.	B.S.
<b>Steel</b>	1350	5415	1805	7220	3155	12635	4285	17145	6990	27975	11400	43320	15200	57760	25525	89345
<b>Kevlar®</b>	1405	5620	2105	8435	3865	15465	5270	21090	8785	35150	14430	54830	19610	74515	32535	113885
<b>HP</b>	1640	6570	2465	9860	4515	18075	6160	24650	10270	41085	16865	64095	22920	87105	38035	133120
<b>HF</b>	1510	6040	2010	8055	3520	14095	4780	19130	7800	31215	12720	48335	16960	64445	28480	99690
<b>HPF</b>	1825	7315	2740	10970	5025	20115	6855	27430	11425	45715	18765	71320	25505	96920	42320	148125
<b>Stainless</b>	1075	4300	1430	5735	2510	10040	3405	13625	5555	22230	9060	34425	12080	45900	20285	71005
<b>HP stainless</b>	1395	5585	2090	8375	3840	15360	5235	20945	8725	34910	14330	54460	19475	74010	32315	113115

Average values in N (M.T.L. = Max Traction Load, B.S. = Breaking Strength)

### FLEXION RESISTANCE

	Z <sub>min</sub>		OUTSIDE IDLER (mm)	INSIDE IDLER (mm)
	Z <sub>min</sub>	Z <sub>minDL</sub>		
Steel	15	25	120	50
Kevlar®	15	-	120	50
HP	25	-	150	80
HF	15	25	80	50
HPF	16	-	100	60
Stainless	19	28	130	130
HP stainless	26	-	150	150

### PULLEYS (FOR MORE DETAILS PLEASE SEE OUR PULLEY CATALOGUE)

N° TEETH	DP	DE	N° TEETH	DP	DE
16	50,93	49,08	40	127,32	125,48
18	57,30	55,45	44	140,06	138,21
19	60,48	58,63	48	152,79	150,94
20	63,66	61,81	60	190,99	189,14
22	70,03	68,18			
24	76,39	74,55			
26	82,76	80,91			
28	89,13	87,28			
30	95,49	93,65			
32	101,86	100,01			



# MEGAFLEX

## AT15

STANDARD WIDTHS (mm)	32	50	75	100	150
Weight for standard belt (gr/m)	363	567	750	1133	1700

Standard compound	<b>white polyurethane thermoplastic 92ShA</b>
Standard back cover	<b>none</b>
Standard tooth cover	<b>none</b>
Standard cord	<b>S&amp;Z zinc plated steel</b>
Standard width tolerance	<b>+/-1 mm</b>
Standard thickness tolerance	<b>+/-0,45 mm</b>
Standard length	<b>from 1500 mm (1905 mm with NFT) till 22590 mm</b>
Standard length tolerance	<b>- 0,5 / -1,5 mm/m</b>
Special version belt on request	<b>See page on 37</b>

TOOTH PROFILE ACCORDING ISO 17396

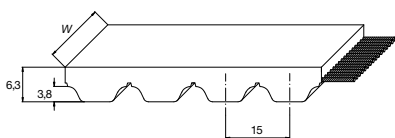

### TOOTH RESISTANCE

RPM (1/min)	0	20	40	60	80	100	200	300	400	500	750	1000	1500	2000	3000	4000	5000	8000
$F_{p\ spec}$ (N/cm)	110	109	106	104	102	101	94	87	84	80	72	66	57	50	39	32	26	-

### TRACTION RESISTANCE

Belt width (mm)	32		50		75		100		150	
	M.T.L.	B.S.	M.T.L.	B.S.	M.T.L.	B.S.	M.T.L.	B.S.	M.T.L.	B.S.
Steel	9120	36480	14440	57760	23200	88160	31200	118560	51245	179360

Average values in N (M.T.L. = Max Traction Load, B.S. = Breaking Strength)

### FLEXION RESISTANCE

	$Z_{min}$	OUTSIDE IDLER (mm)	INSIDE IDLER (mm)
Steel	25	250	120

### PULLEYS (FOR MORE DETAILS, PLEASE SEE OUR PULLEY CATALOGUE)

	N° TEETH	DP	DE
		25	119,37
	28	133,69	131,21
	30	143,24	140,76
	34	162,34	159,86
	40	190,99	188,51
	42	200,54	198,05
	48	229,18	226,70
	54	257,83	255,35
	60	286,48	284,00



# MEGAFLEX

## AT20 - AT20 DL

Standard widths (mm)	25	32	50	75	100	150
Weight for standard belt (gr/m)	250	320	500	750	1000	1500
Weight for DL belt (gr/m)	317	405	633	950	1267	1900

Standard compound	<b>white polyurethane thermoplastic 92ShA</b>
Standard back cover	<b>none</b>
Standard tooth cover	<b>none</b>
Standard cord	<b>zinc plated steel</b>
Standard width tolerance	<b>+/-1 mm</b>
Standard thickness tolerance	<b>+/-0,45 mm</b>
Standard length	<b>from 1500 mm (1900 mm with NFT) till 22600 mm</b>
Standard length tolerance	<b>See page 36</b>
Standard length tolerance for HP, HP stainless, Kevlar®	<b>+0/-0,8 mm/m</b>
Special version belt on request	<b>See on page 37</b>

DL belt available only with standard steel, HF and standard stainless cord.

### TOOTH PROFILE ACCORDING ISO 17396

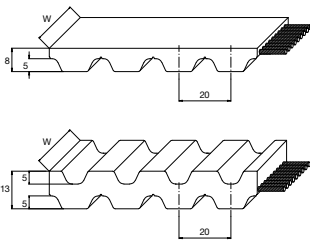

### TOOTH RESISTANCE

RPM (1/min)	0	20	40	60	80	100	200	300	400	500	750	1000	1500	2000	3000	4000	5000	8000
F <sub>p spec</sub> (N/cm)	147	144	142	139	137	135	126	119	112	107	97	88	76	67	58	43	35	-

### TRACTION RESISTANCE

Belt width (mm)	25		32		50		75		100		150	
	M.T.L.	B.S.	M.T.L.	B.S.	M.T.L.	B.S.	M.T.L.	B.S.	M.T.L.	B.S.	M.T.L.	B.S.
Steel	4515	18075	6160	24650	10270	41085	16865	64095	22920	87105	38035	133120
Kevlar®	2810	11245	3515	14060	6325	25305	10360	39365	14060	53425	23295	81545
HP	6080	24320	7600	30400	13680	54720	22400	85120	30400	115520	50375	176320
HF	5025	20115	6855	27430	11425	45715	18765	71320	25505	96920	42320	148125
Stainless	3840	15360	5235	20945	8725	34910	14330	54460	19475	74010	32315	113115
HP Stainless	4275	17100	5340	21375	9615	38475	15750	59850	21375	81225	35420	123975

Average values in N (M.T.L. = Max Traction Load, B.S. = Breaking Strength)

### FLEXION RESISTANCE

	Z <sub>min</sub>		OUTSIDE IDLER (mm)	INSIDE IDLER (mm)
	Z <sub>min</sub>	Z <sub>minDL</sub>		
Steel	18	25	180	120
Kevlar®	18	-	180	120
HP	25	-	250	160
HF	18	25	150	120
Stainless	20	26	200	150
HP stainless	26	-	260	180

### PULLEYS (FOR MORE DETAILS PLEASE SEE OUR PULLEY CATALOGUE)

N° TEETH	DP	DE
18	114,59	111,73
20	127,32	124,47
22	140,06	137,20
24	152,79	149,93
25	159,15	156,30
30	190,99	188,13
32	203,72	200,86
36	229,18	226,33
40	254,65	251,80
48	305,58	302,73
60	381,97	379,12



# MEGAFLEX

## MTD8

STANDARD WIDTHS (mm)	15	20	30	50	85	100	150
Weight for standard belt (gr/m)	90	120	180	300	510	600	900

Standard compound	<b>white polyurethane thermoplastic 92ShA</b>
Standard back cover	<b>none</b>
Standard tooth cover	<b>none</b>
Standard cord	<b>zinc plated steel</b>
Standard width tolerance	<b>+/-0,5 mm</b>
Standard thickness tolerance	<b>+/-0,3 mm</b>
Standard length	<b>from 1504 mm (1904 mm with NFT) till 22600 mm</b>
Standard length tolerance	<b>See on page 36</b>
Special version belt on request	<b>See on page 37</b>

TOOTH PROFILE ACCORDING ISO 13050

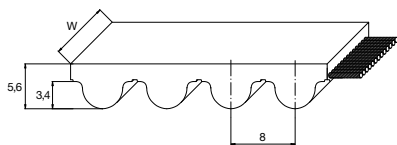

### TOOTH RESISTANCE

RPM (1/min)	0	20	40	60	80	100	200	300	400	500	750	1000	1500	2000	3000	4000	5000	8000
$F_{p\ spec}$ (N/cm)	67	66	65	64	63	63	59	57	54	52	48	45	40	37	31	28	24	18

### TRACTION RESISTANCE

Belt width (mm)	15		20		30		50		85		100		150	
	M.T.L.	B.S.	M.T.L.	B.S.	M.T.L.	B.S.	M.T.L.	B.S.	M.T.L.	B.S.	M.T.L.	B.S.	M.T.L.	B.S.
<b>Steel</b>	895	3590	1295	5185	2090	8375	3590	14360	6615	25135	7665	29125	12880	45085
<b>Kevlar®</b>	1150	4615	1665	6665	2690	10770	4615	18465	8505	32315	9990	37960	16560	57965
<b>HF</b>	940	3760	1355	5430	2190	8775	3760	15045	6930	26330	8030	30510	13495	47230
<b>Stainless</b>	725	2905	1045	4195	1695	6780	2905	11625	5085	20345	5890	23575	9120	36495

Average values in N (M.T.L. = Max Traction Load, B.S. = Breaking Strength)

### FLEXION RESISTANCE

	$Z_{min}$		
		OUTSIDE IDLER (mm)	INSIDE IDLER (mm)
Steel	20	80	40
Kevlar®	20	100	50
HF	20	80	40
Stainless	24	110	80

### PULLEYS (FOR MORE DETAILS, PLEASE SEE OUR PULLEY CATALOGUE)

	N° TEETH	DP	DE	N° TEETH	DP	DE
	20	50,93	49,58	48	122,23	120,86
22	56,02	54,65	56	142,60	141,23	
24	61,12	59,75	64	162,97	161,60	
26	66,21	64,84	72	183,35	181,97	
28	71,30	70,08	112	285,21	283,83	
32	81,49	80,16	144	366,69	365,32	
36	91,67	90,30				
40	101,86	100,49				
44	112,05	110,67				



# MEGAFLEX

## RPP5 - RPP5 DL

Standard widths (mm)	10	15	25	30	50	85	100	150
Weight for standard belt (gr/m)	43	64	85	128	213	363	427	640
Weight for DL belt (gr/m)	47	71	118	142	237	402	473	710

Standard compound	<b>white polyurethane thermoplastic 92ShA</b>
Standard back cover	<b>none</b>
Standard tooth cover	<b>Nylon fabric (NFT)</b>
Standard cord	<b>zinc plated steel</b>
Standard width tolerance	<b>+/-0,5 mm</b>
Standard thickness tolerance	<b>+/-0,2 mm</b>
Standard length	<b>1900 mm till 22600 mm</b>
Standard length tolerance	<b>See on page 36</b>
Special version belt on request	<b>See on page 37</b>

### TOOTH PROFILE ACCORDING ISO 13050

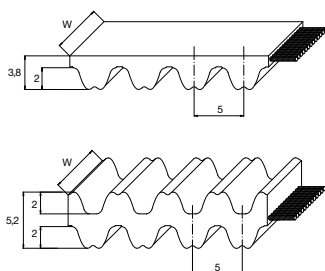

DL belt available only with standard steel, HF and standard stainless cord.

### TOOTH RESISTANCE

RPM (1/min)	0	20	40	60	80	100	200	300	400	500	750	1000	1500	2000	3000	4000	5000	8000
F <sub>p spec</sub> (N/cm)	37	36	36	36	35	35	33	32	30	30	27	26	24	23	21	19	18	15

### TRACTION RESISTANCE

Belt width (mm)	10		15		25		30		50		85		100		150	
	M.T.L.	B.S.	M.T.L.	B.S.	M.T.L.	B.S.	M.T.L.	B.S.	M.T.L.	B.S.	M.T.L.	B.S.	M.T.L.	B.S.	M.T.L.	B.S.
<b>Steel</b>	570	2290	950	3815	1715	6870	2100	8400	3560	14255	6235	24950	7315	29275	11655	44300
<b>HF</b>	530	2135	890	3560	1600	6410	1955	7835	3325	13300	5815	23275	6825	27310	10875	41325
<b>Stainless</b>	470	1880	780	3135	1410	5640	1720	6895	2925	11700	5120	20480	6005	24035	9570	36365

Average values in N (M.T.L. = Max Traction Load, B.S. = Breaking Strength)

### FLEXION RESISTANCE

			OUTSIDE IDLER (mm)	INSIDE IDLER (mm)
	Z <sub>min</sub>	Z <sub>minDL</sub>		
Steel	15	18	60	25
HF	15	18	40	25
Stainless	18	22	65	65

### PULLEYS (FOR MORE DETAILS, PLEASE SEE OUR PULLEY CATALOGUE)

	N° TEETH	DP	DE	N° TEETH	DP	DE
	15	23,87	22,73	40	63,66	62,52
16	25,46	24,32	44	70,03	68,89	
18	28,65	27,50	48	76,39	75,25	
20	31,83	30,69	60	95,49	94,35	
22	35,01	33,87	72	114,59	113,45	
24	38,20	37,05				
26	41,38	40,24				
28	44,56	43,42				
30	47,75	46,60				
32	50,93	49,79				
36	57,30	56,15				



# MEGAFLEX

## RPP8 - RPP8 DL

Standard widths (mm)	15	20	30	50	85	100	150
Weight for standard belt (gr/m)	98	131	196	327	555	653	980
Weight for DL belt (gr/m)	110	147	220	367	623	733	1100

Standard compound	<b>white polyurethane thermoplastic 92ShA</b>
Standard back cover	<b>none</b>
Standard tooth cover	<b>Nylon fabric (NFT)</b>
Standard cord	<b>zinc plated steel</b>
Standard width tolerance	<b>+/-0,5 mm</b>
Standard thickness tolerance	<b>+/-0,3 mm</b>
Standard length	<b>1904 mm till 22600 mm</b>
Standard length tolerance	<b>See on page 36</b>
Special version belt on request	<b>See on page 37</b>

### TOOTH PROFILE ACCORDING ISO 13050

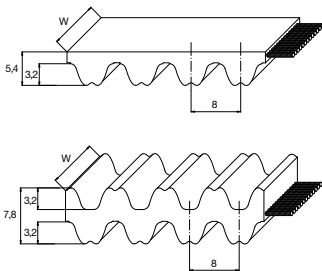

DL belt available only with standard steel, HF and standard stainless cord.

### TOOTH RESISTANCE

RPM (1/min)	0	20	40	60	80	100	200	300	400	500	750	1000	1500	2000	3000	4000	5000	8000
F <sub>p spec</sub> (N/cm)	76	75	74	73	72	71	65	62	60	57	53	50	45	42	38	35	32	25

### TRACTION RESISTANCE

Belt width (mm)	15		20		30		50		85		100		150	
	M.T.L.	B.S.	M.T.L.	B.S.	M.T.L.	B.S.	M.T.L.	B.S.	M.T.L.	B.S.	M.T.L.	B.S.	M.T.L.	B.S.
<b>Steel</b>	1350	5415	2030	8120	3155	12635	5640	22560	10685	40610	12585	47830	20885	73100
<b>Kevlar®</b>	2105	8435	3160	12650	4920	19680	8785	35150	16650	63270	19610	74515	32535	113885
<b>HF</b>	1510	6040	2265	9060	3520	14095	6290	25175	11925	45315	14045	53370	23300	81565
<b>Stainless</b>	1075	4300	1610	6455	2510	10040	4480	17930	8490	32275	10000	38010	16595	58095

Average values in N (M.T.L. = Max Traction Load, B.S. = Breaking Strength)

### FLEXION RESISTANCE

			OUTSIDE IDLER (mm)	INSIDE IDLER (mm)
	Z <sub>min</sub>	Z <sub>minDL</sub>		
Steel	18	25	100	45
Kevlar®	18	-	100	45
HF	18	25	80	40
Stainless	20	28	110	60

### PULLEYS (FOR MORE DETAILS, PLEASE SEE OUR PULLEY CATALOGUE)

	N° TEETH	DP	DE	N° TEETH	DP	DE
	18	45,84	44,49	64	162,97	161,60
22	56,02	54,65	72	183,35	181,97	
24	61,12	59,74	90	229,18	227,81	
26	66,21	64,84	144	366,69	365,32	
28	71,30	69,93	192	488,92	487,55	
32	81,49	80,12				
36	91,67	90,30				
38	96,77	95,39				
44	112,05	110,67				
48	122,23	120,86				
54	137,51	136,14				



# MEGAFLEX

## RPP14 - RPP14 DL

Standard widths (mm)	25	40	55	85	115	150
Weight for standard belt (gr/m)	308	493	678	1048	1418	1850
Weight for DL belt (gr/m)	350	560	770	1190	1610	2100

Standard compound	<b>white polyurethane thermoplastic 92ShA</b>
Standard back cover	<b>none</b>
Standard tooth cover	<b>Nylon fabric (NFT)</b>
Standard cord	<b>zinc plated steel</b>
Standard width tolerance	<b>+/-1 mm</b>
Standard thickness tolerance	<b>+/-0,4 mm</b>
Standard length	<b>1904 mm till 22596 mm</b>
Standard length tolerance	<b>See on page 36</b>
Special version belt on request	<b>See on page 37</b>

### TOOTH PROFILE ACCORDING ISO 13050

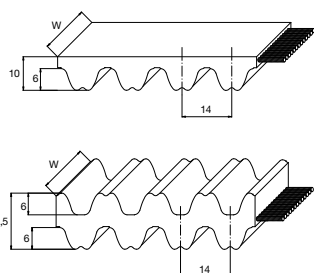

DL belt available only with standard steel, HF and standard stainless cord.

### TOOTH RESISTANCE

RPM (1/min)	0	20	40	60	80	100	200	300	400	500	750	1000	1500	2000	3000	4000	5000	8000
F <sub>p spec</sub> (N/cm)	140	137	135	133	131	128	118	111	105	101	91	84	75	62	52	40	30	-

### TRACTION RESISTANCE

Belt width (mm)	25		40		55		85		115		150	
	M.T.L.	B.S.	M.T.L.	B.S.	M.T.L.	B.S.	M.T.L.	B.S.	M.T.L.	B.S.	M.T.L.	B.S.
Steel	6080	24320	10640	42560	16000	60800	26400	100320	39085	136800	52110	182400
Stainless	4275	17100	7480	29925	11250	42750	18560	70535	27480	96185	36640	128250

Average values in N (M.T.L. = Max Traction Load, B.S. = Breaking Strength)

### FLEXION RESISTANCE

			OUTSIDE IDLER (mm)	INSIDE IDLER (mm)
	Z <sub>min</sub>	Z <sub>minDL</sub>		
Steel	32	40	250	145
Stainless	38	44	280	170

### PULLEYS (FOR MORE DETAILS, PLEASE SEE OUR PULLEY CATALOGUE)

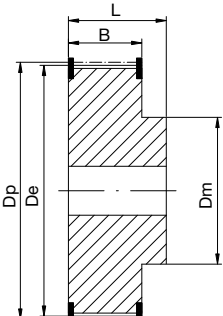
	N° TEETH	DP	DE	N° TEETH	DP	DE
		32	142,60	139,81	112	499,11
	34	151,52	148,73	144	641,71	638,92
	38	169,34	166,55	168	748,66	745,87
	40	178,25	175,46	192	855,61	852,82
	44	196,08	193,29	216	962,57	959,78
	48	213,90	211,11			
	56	249,55	246,76			
	64	285,20	282,41			
	72	320,86	318,07			
	80	356,51	353,72			
	90	401,07	398,28			

# MEGAFLEX

## P2



STANDARD WIDTHS (mm)	25	50	75	100	150
Weight for standard belt (gr/m)	105	210	315	420	630

Standard compound	<b>white polyurethane thermoplastic 92ShA</b>
Standard back cover	<b>none</b>
Standard tooth cover	<b>none</b>
Standard cord	<b>zinc plated steel</b>
Standard width tolerance	<b>+/-0,5 mm</b>
Standard thickness tolerance	<b>+/-0,3 mm</b>
Standard length	<b>from 1500 mm (1900 mm with NFT) till 22600 mm</b>
Standard length tolerance	<b>See on page 36</b>
Special version belt on request	<b>See on page 37</b>

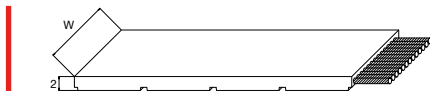

### TRACTION RESISTANCE

Belt width (mm)	25		50		75		100		150	
	M.T.L.	B.S.	M.T.L.	B.S.	M.T.L.	B.S.	M.T.L.	B.S.	M.T.L.	B.S.
<b>Steel</b>	1125	4510	2255	9025	3800	14440	5460	20755	9025	31585
<b>Stainless</b>	895	3585	1790	7170	3020	11475	4340	16495	7170	25100

Average values in N (M.T.L. = Max Traction Load, B.S. = Breaking Strength)

### FLEXION RESISTANCE

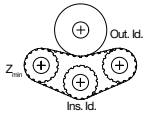
	Z <sub>min</sub>		
		OUTSIDE IDLER (mm)	INSIDE IDLER (mm)
Steel	45	90	50
Stainless	60	150	80

### PULLEYS (FOR MORE DETAILS, PLEASE SEE OUR PULLEY CATALOGUE)

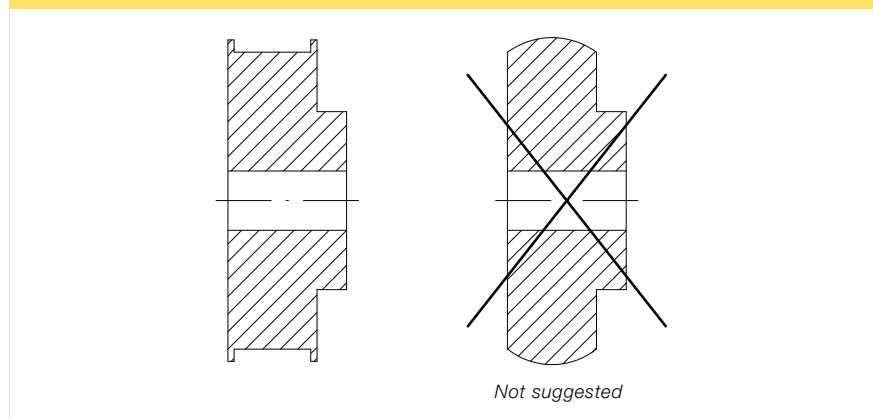

# MEGAFLEX

## ATG10



STANDARD WIDTHS (mm)	25	32	50	75	100	150
Weight for standard belt (gr/m)	180	220	330	480	630	930

Standard compound	<b>white* polyurethane thermoplastic 92ShA</b>
Standard back cover	<b>none</b>
Standard tooth cover	<b>none</b>
Standard cord	<b>zinc plated steel</b>
Standard width tolerance	<b>+/-0,5 mm</b>
Standard thickness tolerance	<b>+/-0,3 mm</b>
Standard length	<b>from 1500 mm (1900 mm with NFT) till 22600 mm</b>
Standard length tolerance	<b>See on page 36</b>
Special version belt on request	<b>See on page 37</b>

(\* In this photo, MEGAFLEX FCM with light blue compound)

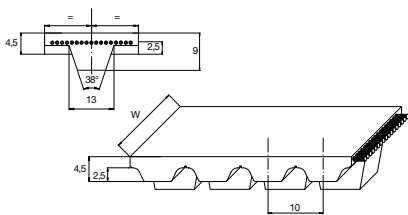

### TOOTH RESISTANCE

RPM (1/min)	0	20	40	60	80	100	200	300	400	500	750	1000	1500	2000	3000	4000	5000	8000
F <sub>p spec</sub> (N/cm)	74	72	71	71	70	69	65	62	60	58	53	50	44	40	35	30	27	20

### TRACTION RESISTANCE

Belt width (mm)	25		32		50		75		100		150	
	M.T.L.	B.S.	M.T.L.	B.S.	M.T.L.	B.S.	M.T.L.	B.S.	M.T.L.	B.S.	M.T.L.	B.S.
Steel	3155	12635	4285	17145	6990	27975	11400	43320	15200	57760	25525	89345
Kevlar®	2590	10370	3515	14075	5740	22970	9360	35565	12480	47420	20955	73355
HF	3520	14095	4780	19130	7800	31215	12720	48335	16960	64445	28480	99690
Stainless	2510	10040	3405	13625	5555	22230	9060	34425	12080	45900	20285	71005

Average values in N (M.T.L. = Max Traction Load, B.S. = Breaking Strength)

### FLEXION RESISTANCE

	Z <sub>min</sub>		
		OUTSIDE IDLER (mm)	INSIDE IDLER (mm)
Steel	25	120	100
Kevlar®	25	120	100
HF	25	100	80
Stainless	31	130	130

### PULLEYS (FOR MORE DETAILS, PLEASE SEE OUR PULLEY CATALOGUE)

	N° TEETH	DP	DE
		25	79,58
	27	85,94	84,10
	30	95,49	93,65
	32	101,86	100,01
	36	114,59	112,74
	40	127,32	125,48
	48	152,79	150,94
	60	190,99	189,14

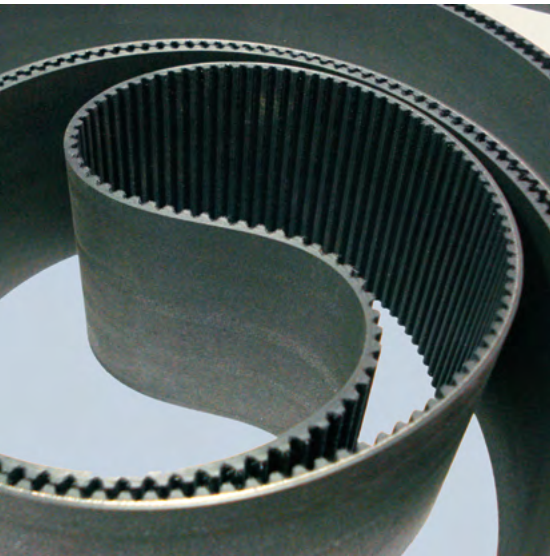

# ANTISTATIC POLYURETHANE

## TIMING BELTS

Megadyne now offers antistatic belts. Under certain conditions, a polyurethane belt may build up a significant static electric charge. For applications where belts are intended for operation in a potentially explosive atmosphere or near electrical components, polyurethane belts should be sufficiently conductive to dissipate this electrical charge. Belts can be constructed (using proper nylon fabric coating) with a relatively low electrical resistance characteristic and are typically referred to as “static conductive” surfaces or “antistatic” surfaces. The test methods for determining the surface resistive properties of a belt are based on ISO 9563, “Belt Drives - Electrical Conductivity of Anti-static Endless Synchronous Belts - Characteristics and Test Method”. To be antistatic the electrical resistance, in ohms, of a belt measured in accordance with the test method of norm ISO 9563, should not exceed:

$$\text{Resistance} = \Omega = \frac{(6 \cdot 10^5) \cdot L}{W}$$

where:

- L = is the dry distance between electrodes (7 grooves, 6 teeth between contacts)
- W = is the width of the belt

*L and W are expressed in the same units (mm or inches).*

*Megadyne's antistatic belts are produced with black polyurethane as standard.*

### TYPICAL APPLICATIONS

- PC boards or other electronic assemblies industry
- Semiconductor processing
- Paper industry
- Power transmission applications in the textile industry
- Chemical environment power transmissions
- Clean room power transmissions

# MEASURING LENGTHS

## LENGTH TOLERANCES

MEGAFLEX are custom-made manufactured belts, they are available tooth by tooth on the following range:

- from 1500 mm to 22600 mm length
- from 1900 mm to 22600 mm length for nylon fabric teeth version

For AT10 and AT20 with HP, HPF and Kevlar® cords and for AT15, check length tolerance on belt data pages 25, 26 and 27:

### LENGTH TOLERANCES (mm)

UP TO	UP TO	UP TO
1700 mm ± 1,13	3750 mm ± 2,03	8000 mm ± 3,70
1900 mm ± 1,22	4000 mm ± 2,11	9000 mm ± 4,09
2120 mm ± 1,31	4250 mm ± 2,24	11000 mm ± 4,80
2240 mm ± 1,36	4500 mm ± 2,32	12000 mm on request
2360 mm ± 1,44	4750 mm ± 2,40	13000 mm on request
2500 mm ± 1,49	5300 mm ± 2,64	14000 mm on request
2650 mm ± 1,57	5600 mm ± 2,72	15000 mm on request
2800 mm ± 1,61	6000 mm ± 2,92	16000 mm on request
3000 mm ± 1,70	6300 mm ± 3,04	17000 mm on request
3150 mm ± 1,74	6700 mm ± 3,19	18000 mm on request
3350 mm ± 1,82	7100 mm ± 3,35	19000 mm on request
3550 mm ± 1,91	7500 mm ± 3,51	20000 mm on request

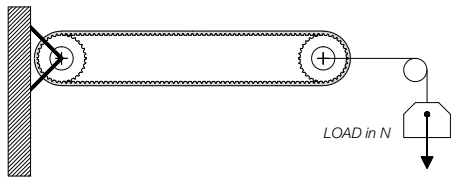

The above length tolerances are tested with following system.

### MEASURING LOAD IN N FOR BELT WIDTH

TYPE	WIDTH (mm)	6	10	12	16	20	25	32	50	75	100	150
T5		20	40		60		90	120	190	280		
T10					90		140	170	270	420		
T20							265	340	540	800	1100	
AT5			50		80		125	160	250	375		
AT10							270	340	540	800	1100	
AT15								640	1030	1570	2100	3150
AT20								500	800	1200	1600	

TYPE	WIDTH (mm)	10	15	20	25	30	40	50	55	85	100	115	150
MTD8			165	220		330		550		935	1100		1650
RPP5		50	75		125	150		250		425	500		750
RPP8			165	220		330		550		935	1100		1650
RPP14					800		1280		1760	2720		3680	4800

TYPE	WIDTH (mm)			12,7	19,05	25,4	38,1	50,8	76,2	101,6	152,4	
XL				40	69	90	140					
L				63	94	125	180					
H						140	200	260				
XH							600	800	1200			

Special length tolerance on request.

# ENGINEERED BELTS

## MEGAFLEX FEASIBILITY TABLE

	XL	L	H	XH	T5	T10	T20	AT5	AT10	AT15	AT20	MTD8	RPP5	RPP8	RPP14	ATG10	P2
Steel Cords	O	O	O	O	O	O	O	O	O	O	O	O	O	O	O	O	O
Kevlar Cords	M	X	M	X	M	M	M	M	M	X	M	M	X	M	X	M	X
High Performance Cords	X	X	X	X	M	M	M	M	M	X	M	X	X	X	X	X	X
High Flexibility Cords	M	M	M	M	M	M	M	M	M	X	M	M	M	M	X	M	X
High Performance Flexibility	X	X	X	X	M	M	M	M	M	X	X	X	X	X	X	X	X
Stainless Steel Cords	M	M	M	M	M	M	M	M	M	X	M	M	M	M	M	M	M
High Performance Stainless Steel	X	X	X	X	M	M	M	M	M	X	M	X	X	X	X	X	X
Fiberglass Cords	X	X	X	X	X	X	X	X	X	X	X	X	X	X	X	X	X
Polyestere Cords	X	X	X	X	X	X	X	X	X	X	X	X	X	X	X	X	X
Bifilar Twisting of Cords ( S-Z)	M	M	M	M	M	M	M	M	M	M	M	M	M	M	M	M	M
Nylon Fabric Teeth	M	M	M	M	M	M	M	M	M	M	M	M	O	O	O	M	M
Nylon Fabric Back	X	X	X	X	X	X	X	X	X	X	X	X	X	X	X	X	X
Nylon Fabric Teeth Antistatic	M	M	M	M	M	M	M	M	M	M	M	M	M	M	M	X	M
FDA Compound	X	M	M	M	M	M	M	M	M	X	M	M	X	X	X	M	X
Avafc 2 / 4 mm 60° ShA Cover	M	M	M	M	M	M	M	M	M	M	M	M	M	M	M	M	M
Avafc 2 / 4 mm 70° ShA Cover	M	M	M	M	M	M	M	M	M	M	M	M	M	M	M	M	M
Avafc 2 / 4 mm 85° ShA Cover	M	M	M	M	M	M	M	M	M	M	M	M	M	M	M	M	M
Pu Yellow Coating 50° ShA	M	M	M	M	M	M	M	M	M	M	M	M	M	M	M	M	M
APL	M	M	M	M	M	M	M	M	M	M	M	M	M	M	M	M	M
Fishbone Polyurethane Cover	M	M	M	M	M	M	M	M	M	M	M	M	M	M	M	M	M
Red Grip	M	M	M	M	M	M	M	M	M	M	M	M	M	M	M	M	M
Durataq®	M	M	M	M	M	M	M	M	M	M	M	M	M	M	M	M	M
Supergrip	M	M	M	M	M	M	M	M	M	M	M	M	M	M	M	M	M
Minigrip	M	M	M	M	M	M	M	M	M	M	M	M	M	M	M	M	M
Porol Black	M	M	M	M	M	M	M	M	M	M	M	M	M	M	M	M	M
Linatex 42° ShA Cover	M	M	M	M	M	M	M	M	M	M	M	M	M	M	M	M	M
Tenax 40° / 45° ShA Cover	M	M	M	M	M	M	M	M	M	M	M	M	M	M	M	M	M
White Alimentary Rubber Cover	M	M	M	M	M	M	M	M	M	M	M	M	M	M	M	M	M
Neoprene Rubber 70°ShA	M	M	M	M	M	M	M	M	M	M	M	M	M	M	M	M	M
Gummy Correx Ambra Parablond Cover	M	M	M	M	M	M	M	M	M	M	M	M	M	M	M	M	M
NBR Cover	M	M	M	M	M	M	M	M	M	M	M	M	M	M	M	M	M
Linaplus FG	M	M	M	M	M	M	M	M	M	M	M	M	M	M	M	M	M
Honey Comb	M	M	M	M	M	M	M	M	M	M	M	M	M	M	M	M	M
Cleats	M	M	M	M	M	M	M	M	M	M	M	M	M	M	M	M	M
Double Teeth only for Steel Cords <small>(Hf and Stainless Steel Cords whenever feasible, please check with our Staff)</small>	M	M	M	M	M	M	M	M	M	X	M	X	M	M	M	X	X
Min Length (mm)	1504	1505	1511	1511	1500	1500	1500	1500	1500	1500	1500	1504	-	-	-	1500	1500
Min Length with NFT (mm)	1905	1905	1905	1911	1900	1900	1900	1900	1900	1905	1900	1904	1900	1904	1904	1900	1900
Max Length (mm)	22595,84	22593,30	22593,30	22580,60	22600	22600	22600	22600	22600	22590	22600	22600	22600	22600	22596	22600	22600
Max Width for Belt (mm)	152,4	152,4	152,4	152,4	150	150	150	150	150	150	150	150	150	150	150	150	150

O: Ex stock | M: On request with Minimum Quantity | X: Not available

# CLEATS



Megadyne's timing belts can be customised with profiles welded on the backside. All the cleats are made using the same thermoplastic polyurethane as the MEGAFLEX body (white PU 92 ShA).

The profiles are attached with the best technology available, the High Vibration System.

The production process for these profiles is very flexible; Megadyne can design any profile to meet the specific requirement of the customer, in order to check and develop all the needed special profiles.

## STANDARD PARALLELEPIPED PROFILES

Megadyne can produce, as standard cleats, the parallelepiped profiles, starting from a thermoplastic polyurethane strip roll and cutting to the requested profile dimension.

The  $t$  value (thickness) is available from 2 to 13 mm, the  $h$  value (height) can be from 3 to 120 mm and the width can be 150 mm maximum.

Megadyne recommends that the profile spacing were multiple of the belt pitch; in any case, for special inquiries and small quantities, it is also possible to weld the profiles in other positions; the feasible dimensions, with the standard process tolerances, are introduced in the following sketch.

The tolerances on the position are  $\pm 0.5$  mm.

The cumulative tolerance on the spacing of the profiles is the same as the length tolerance of our standard belts ( $\pm 0.8$  mm/m) (tighter tolerances are available on request).

Due to the welding process, a bead of material develops at the meeting point of the profile and the belt.

In any case, Megadyne always removes this welding bead.

## PROFILE MECHANICAL RESISTANCE

In order to find the right cleat dimensions, please consider the following factors:

- Section base cleats resistance ( $R$ ) becomes bigger, increasing:
  - Cleats width ( $w$ )
  - Cleats thickness ( $t$ )
- Cleat stiffness is bigger:
  - Increasing cleat thickness ( $t$ )
  - Using special moulded profiles, like STDE0006, STDE0008, STDE0010 and STMI0012 types

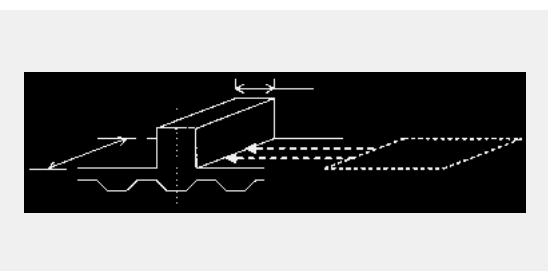
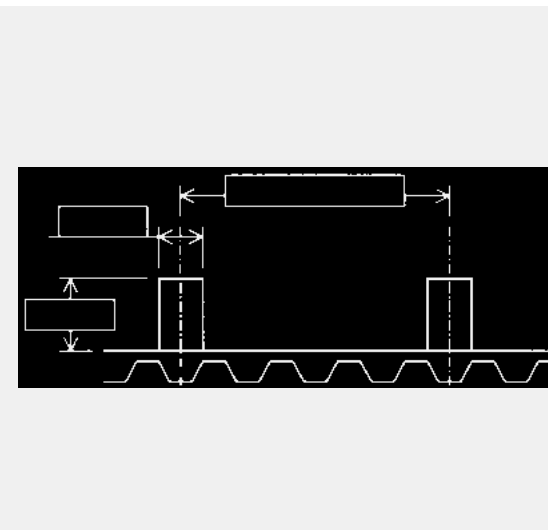



# CLEATS

## MINIMUM NUMBER OF PULLEY TEETH FOR BELTS WITH PROFILES

The profiles presence can change the belt flexibility properties; the two factors that affect the original flexibility are the following:

- Thickness of the cleat “foot“ (size of the base). Flexibility decreases when the welded area dimensions increase.
- Position of the welded profile on the belt. When the cleats are welded in the axis with the teeth, the belt flexibility is better than when cleats are welded in the axis with the little nose.

Please find, in the following table, the flexibility properties of cleated belts.

CLEATS OVER A TOOTH						
CLEAT THICKNESS	4	5	6	8	10	12
<b>XL</b>	18	18	25	40	50	100
<b>L</b>	12	12	18	30	40	60
<b>H</b>	14	14	14	18	25	45
<b>XH</b>	18	18	18	18	18	20
<b>T5/AT5</b>	18	18	25	40	50	100
<b>T10/AT10</b>	14	14	14	18	25	45
<b>AT15</b>	16	16	16	18	25	40
<b>T20/AT20</b>	18	18	18	18	18	20
<b>RPP5</b>	18	18	25	40	50	100
<b>RPP8</b>	14	14	14	18	25	45
<b>RPP14</b>	18	18	18	18	18	20

CLEATS NOT OVER A TOOTH						
CLEAT THICKNESS	4	5	6	8	10	12
<b>XL</b>	45	45	50	60	100	-
<b>L</b>	40	40	45	55	60	80
<b>H</b>	25	25	30	45	50	65
<b>XH</b>	20	20	30	40	45	54
<b>T5/AT5</b>	45	45	50	60	100	-
<b>T10/AT10</b>	30	30	40	45	50	65
<b>AT15</b>	20	20	30	40	45	54
<b>T20/AT20</b>	20	20	30	40	45	54
<b>RPP5</b>	45	45	50	60	100	-
<b>RPP8</b>	30	30	40	45	50	65
<b>RPP14</b>	20	20	30	40	45	54

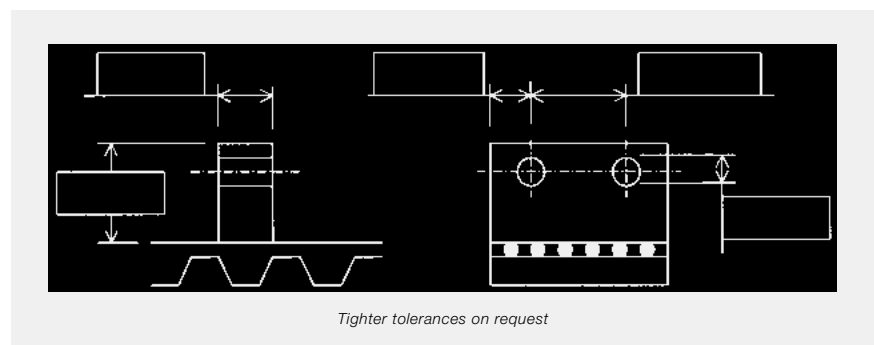

## STANDARD PARALLELEPIPED PROFILES WITH HOLES

Parallelepiped profiles are available also with holes to satisfy special applications. Please find below the standard tolerances for this kind of cleats.

For belt flexibility and mechanical resistance, please kindly refer to values of cleats without holes.

## MOULDED CLEATS

Using a high-performance injection system, Megadyne can produce any profile designed by the customer. For cleats not yet present in following pages, Megadyne can produce dedicated mould according to customer requirements. For belt flexibility and mechanical resistance, please kindly refer to the standard parallelepiped profiles section.



# CLEATS

If the needed cleat is not yet present in the following tables, please contact Megadyne staff.

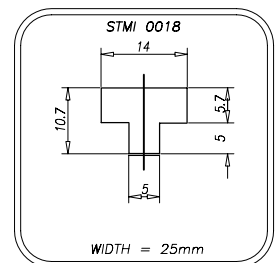
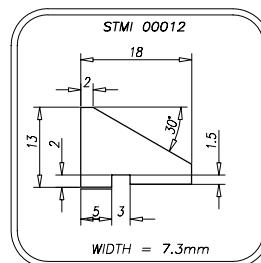
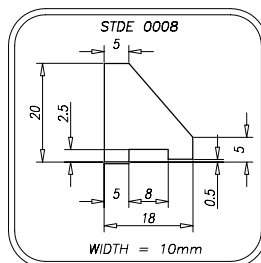
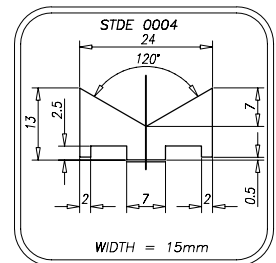
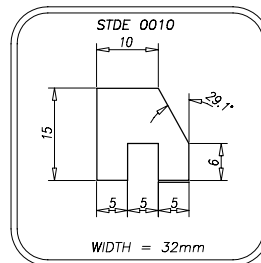
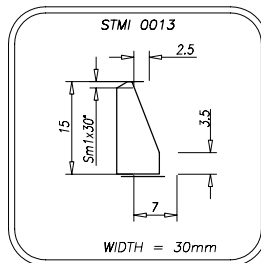
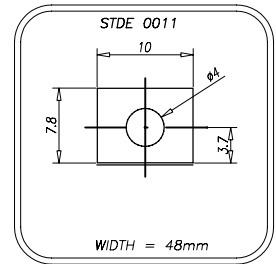
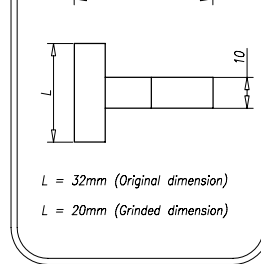
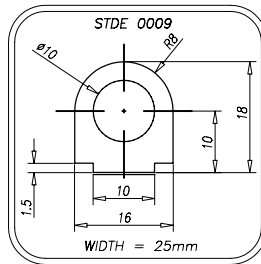
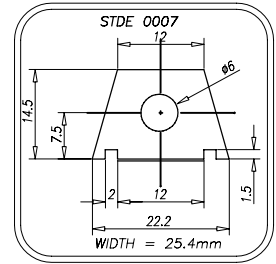
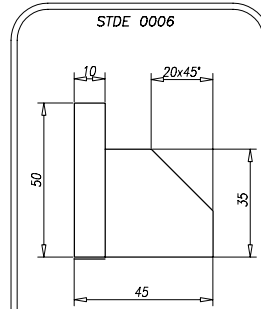
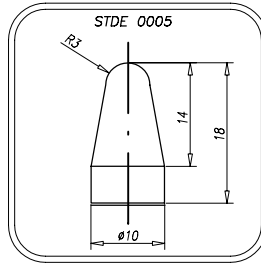
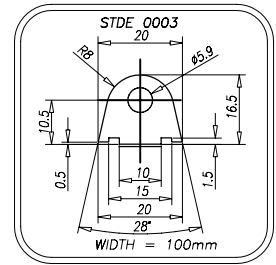
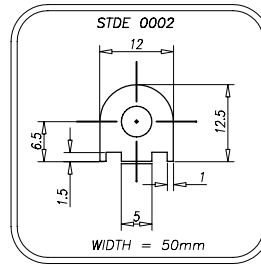



# CLEATS

If the needed cleat is not yet present in the following tables, please contact Megadyne staff.

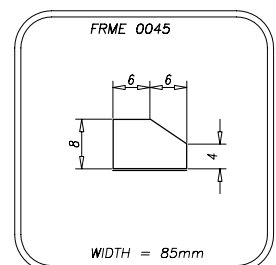
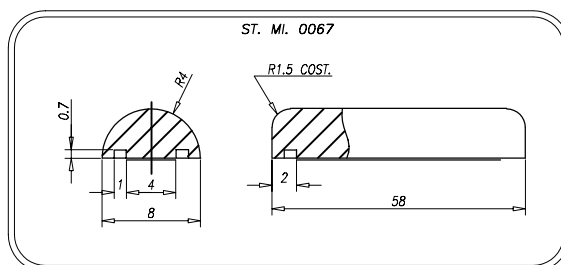
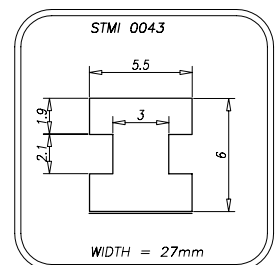
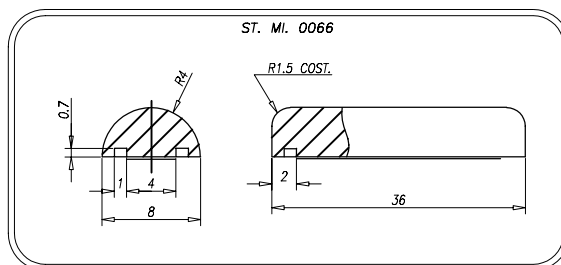
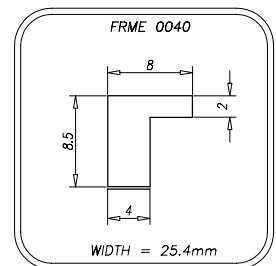
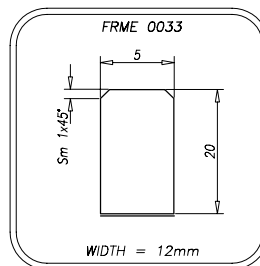
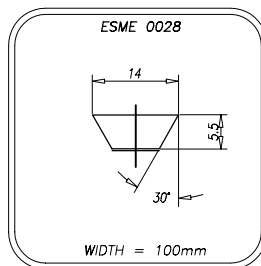
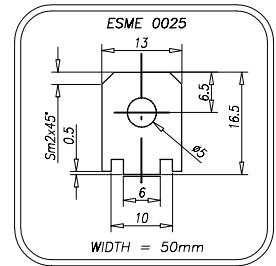
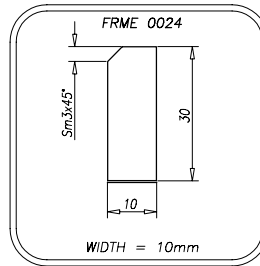
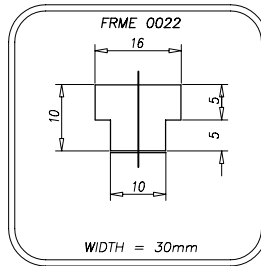
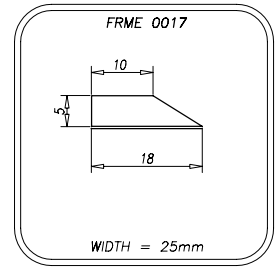
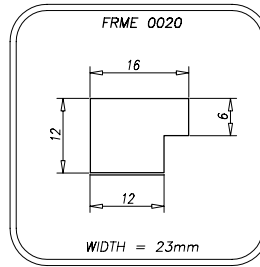
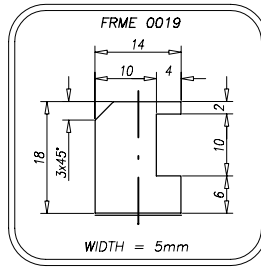



# CLEATS

If the needed cleat is not yet present in the following tables, please contact Megadyne staff.

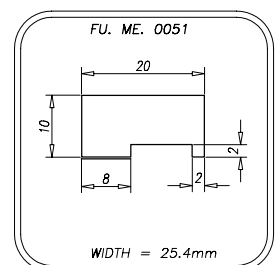
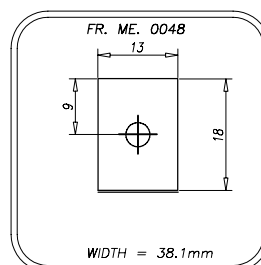
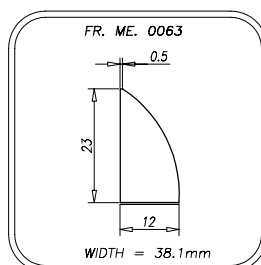
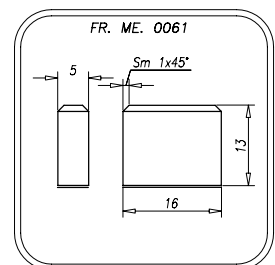
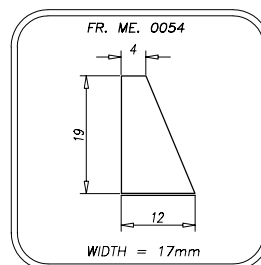
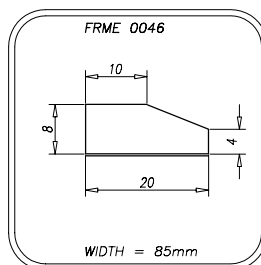
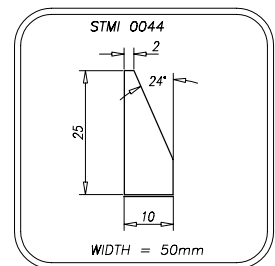
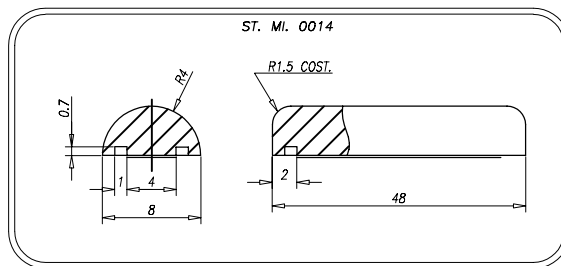
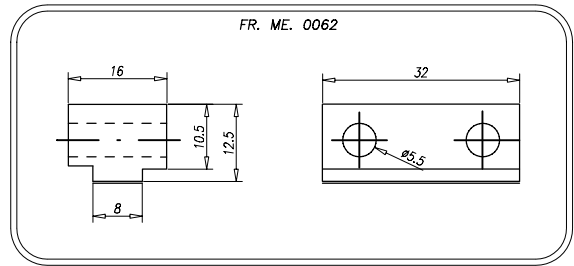
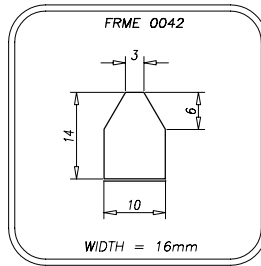
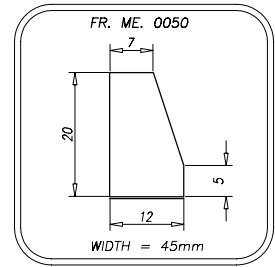
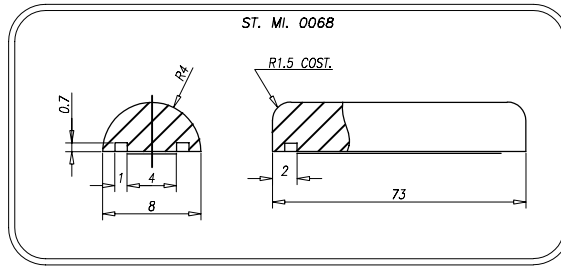



# CLEATS

If the needed cleat is not yet present in the following tables, please contact Megadyne staff.

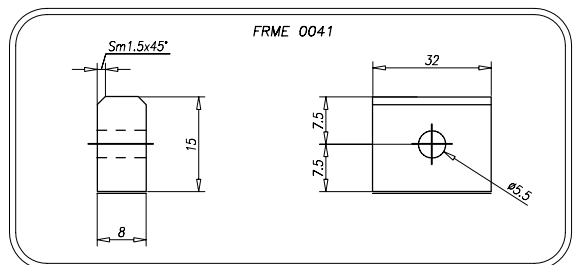
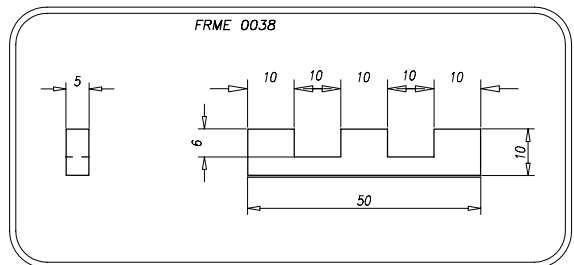
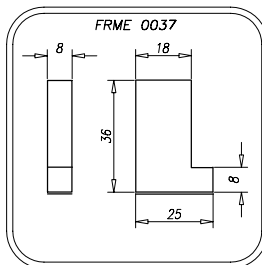
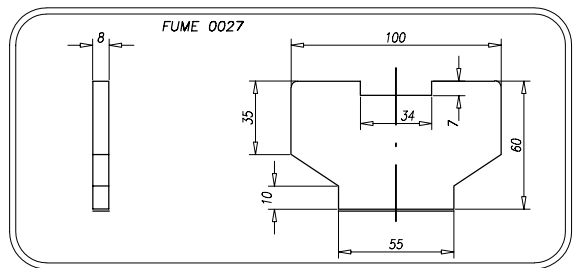
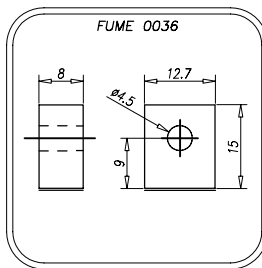
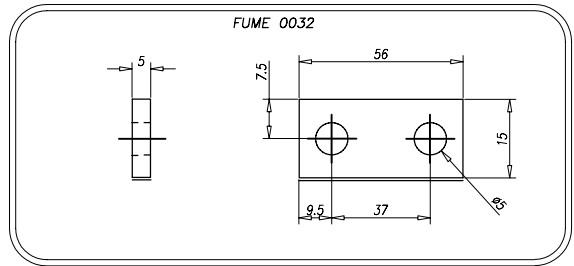
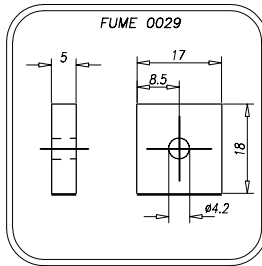
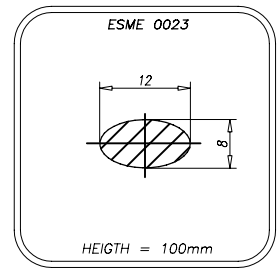
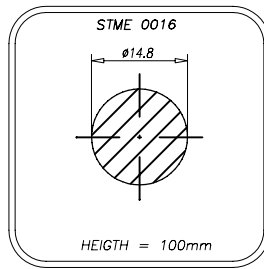
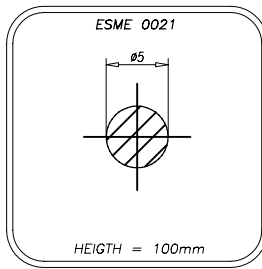



# CLEATS

If the needed cleat is not yet present in the following tables, please contact Megadyne staff.

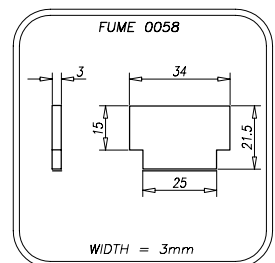
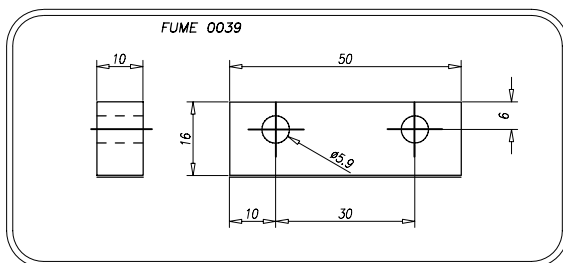
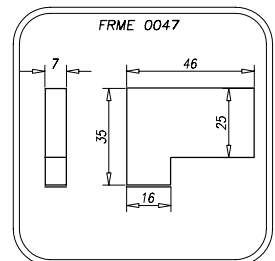
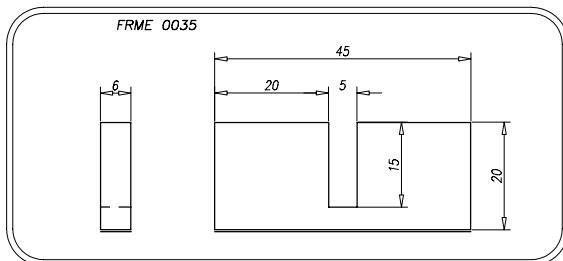
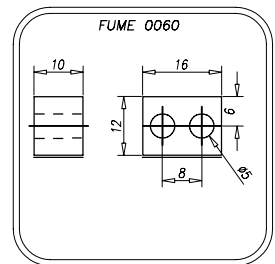
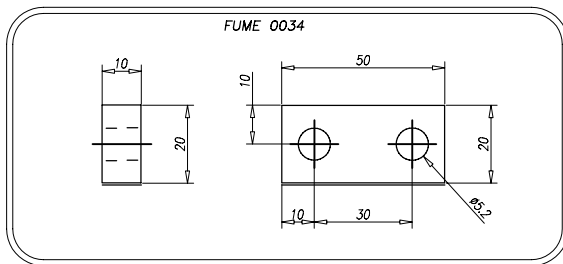
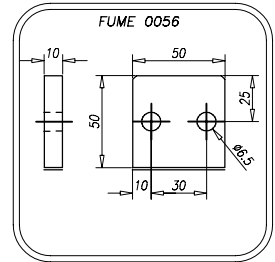
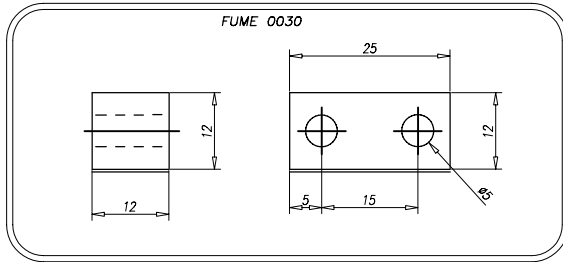
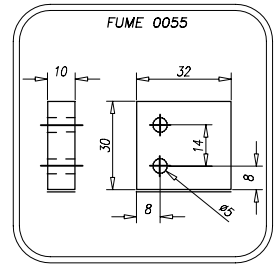
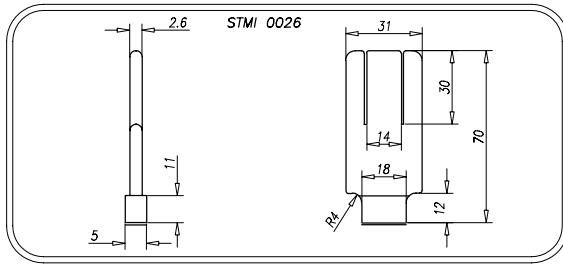



# CLEATS

If the needed cleat is not yet present in the following tables, please contact Megadyne staff.

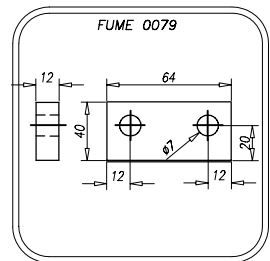
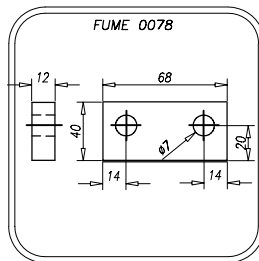
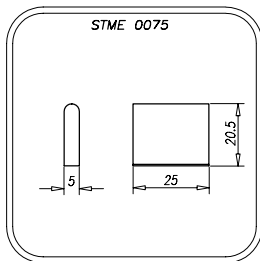
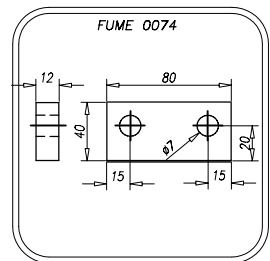
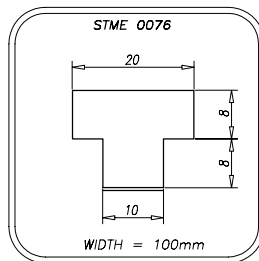
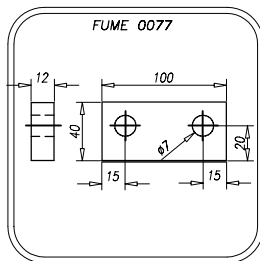
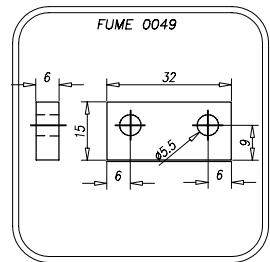
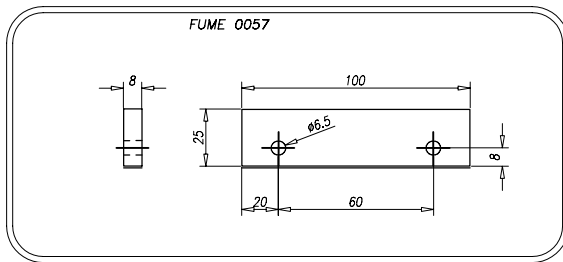
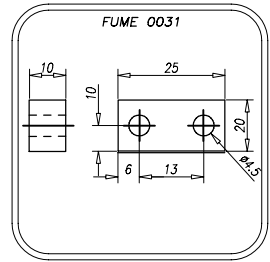
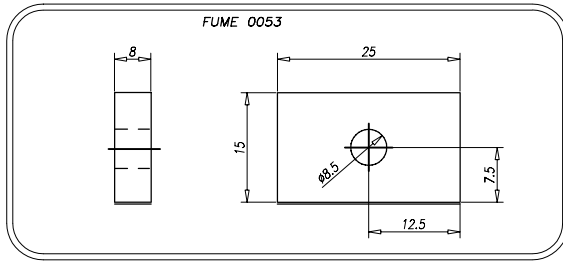
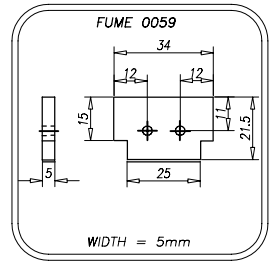
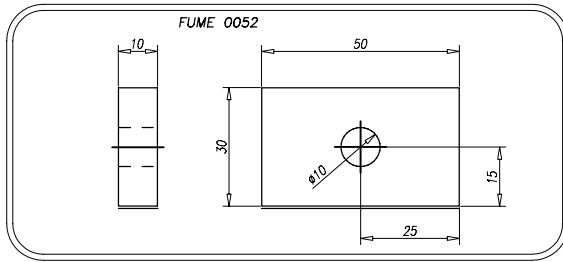



# CLEATS

If the needed cleat is not yet present in the following tables, please contact Megadyne staff.

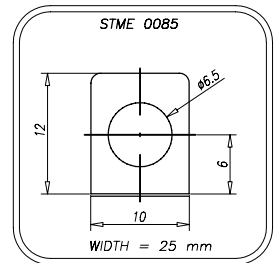
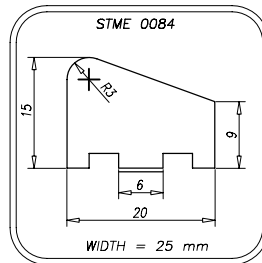
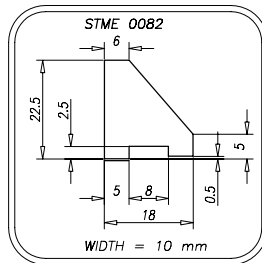
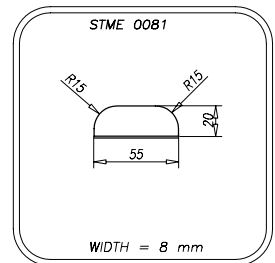
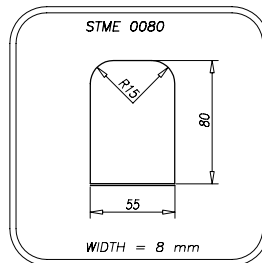
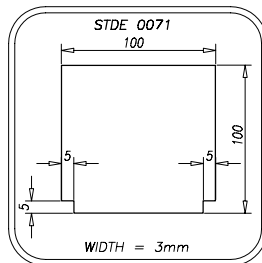
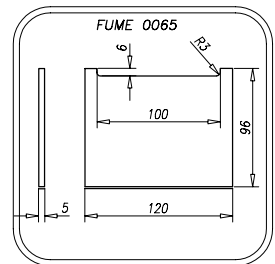
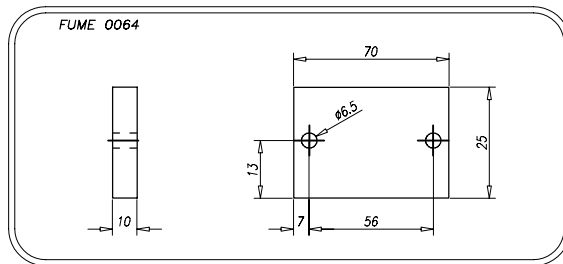
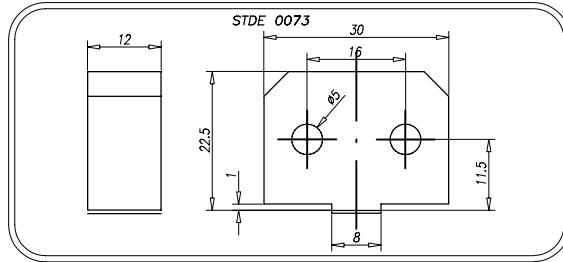
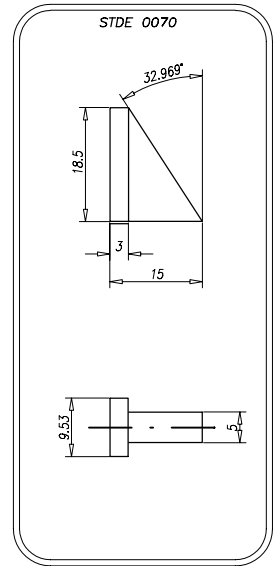
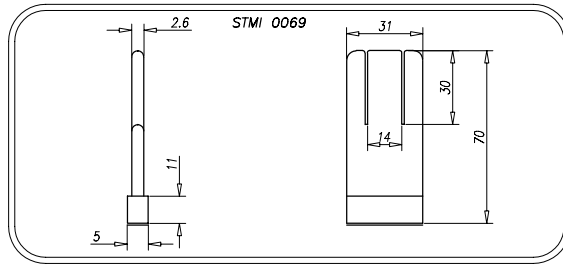



# CLEATS

If the needed cleat is not yet present in the following tables, please contact Megadyne staff.

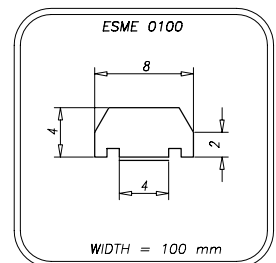
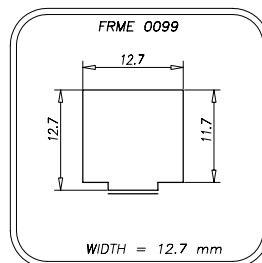
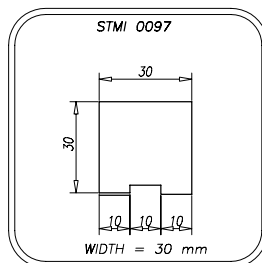
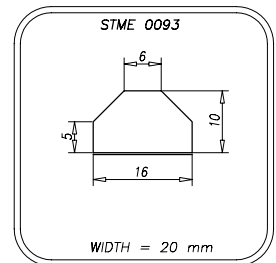
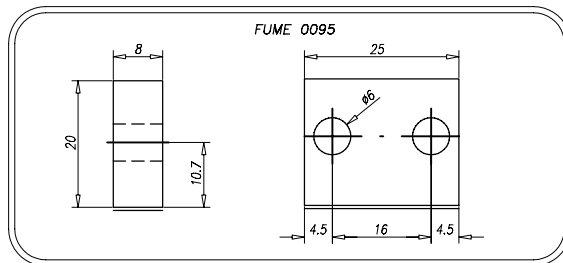
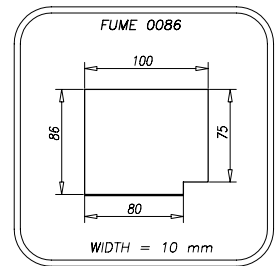
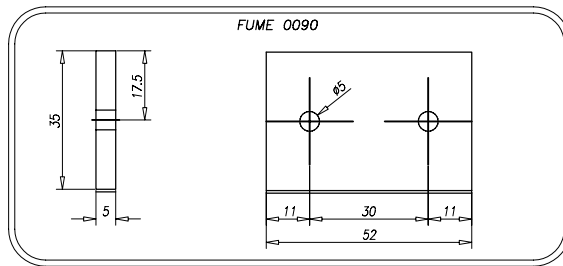
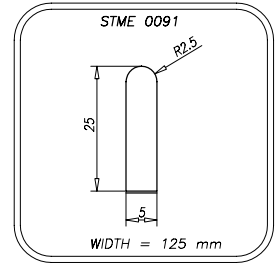
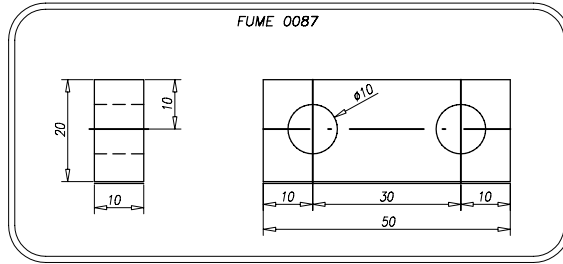
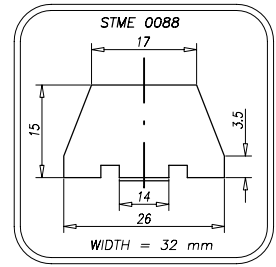
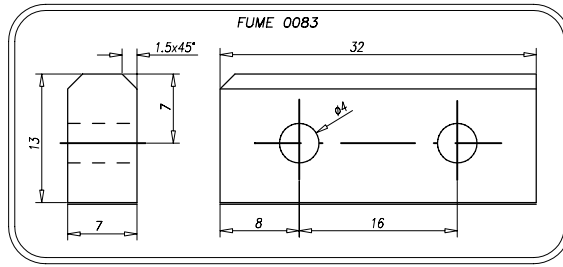



# CLEATS

If the needed cleat is not yet present in the following tables, please contact Megadyne staff.

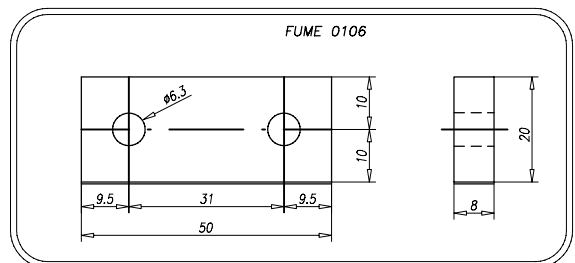
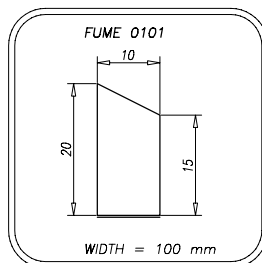
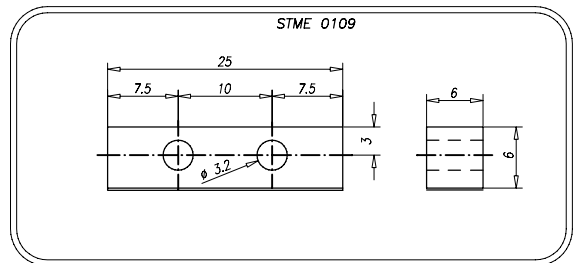
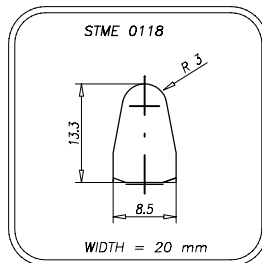
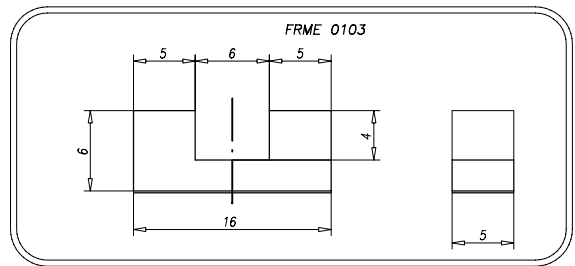
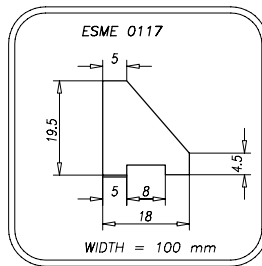
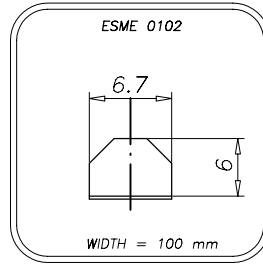
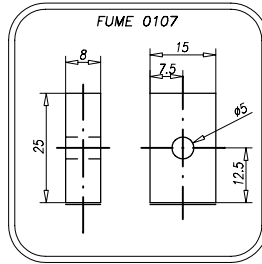
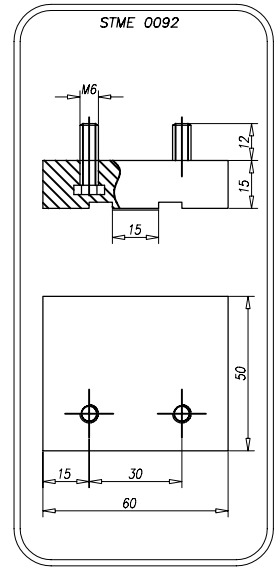
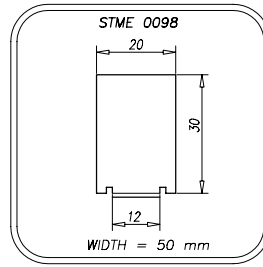
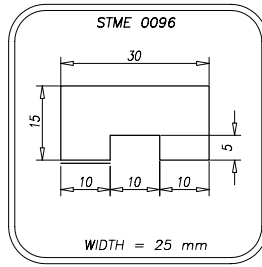



# CLEATS

If the needed cleat is not yet present in the following tables, please contact Megadyne staff.

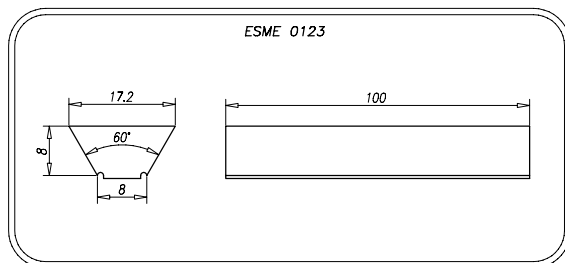
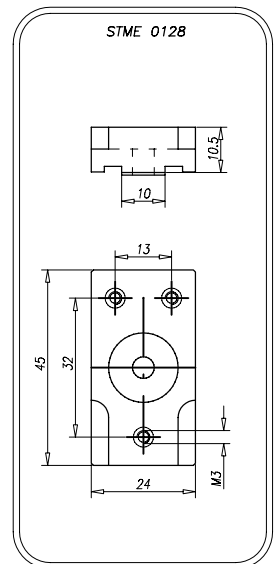
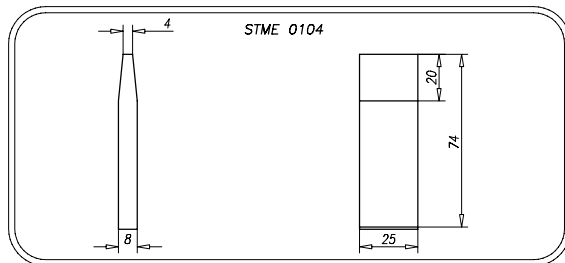
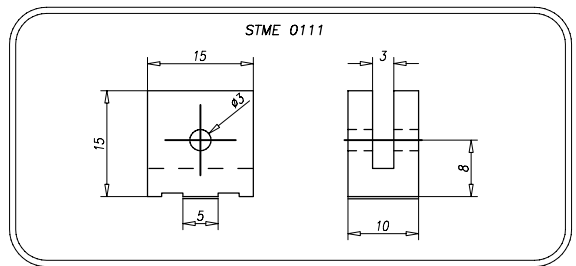
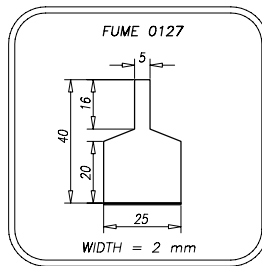
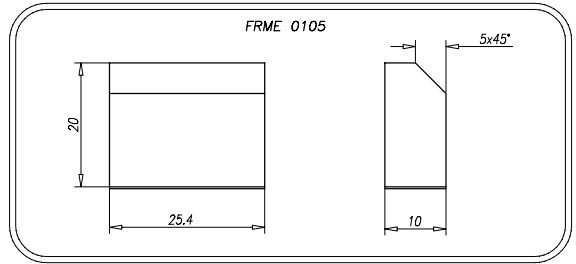
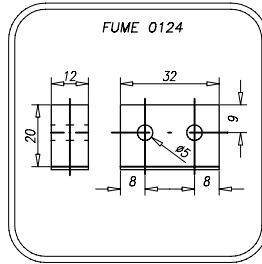
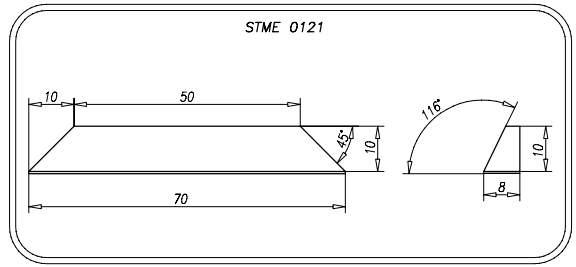
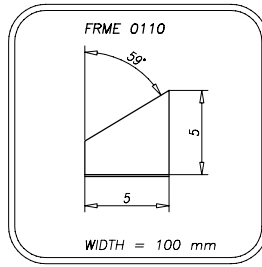



# CLEATS

If the needed cleat is not yet present in the following tables, please contact Megadyne staff.

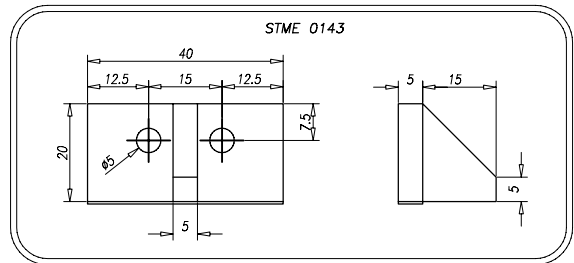
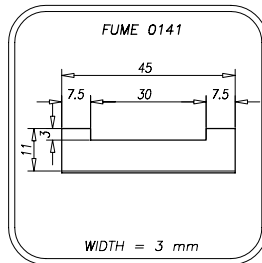
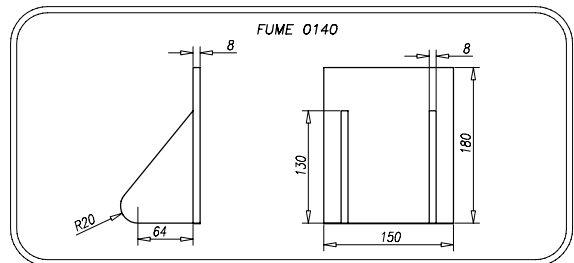
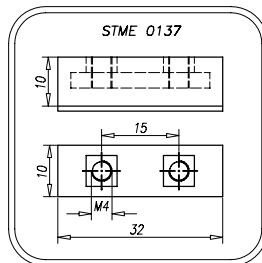
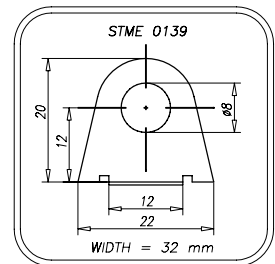
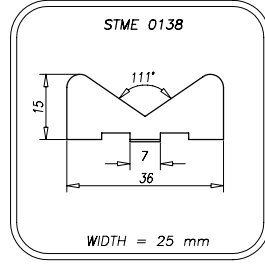
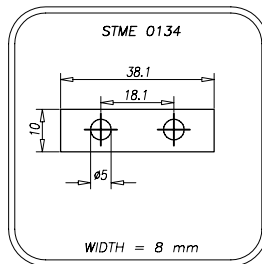
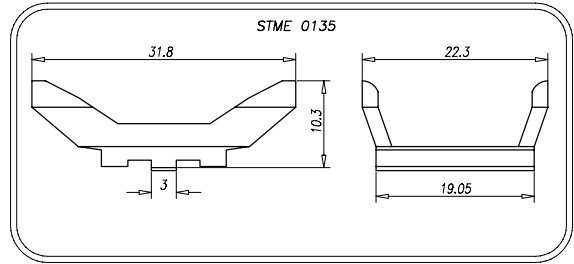
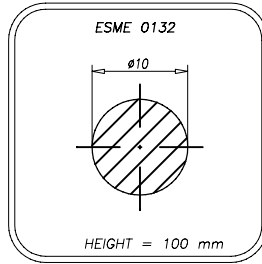
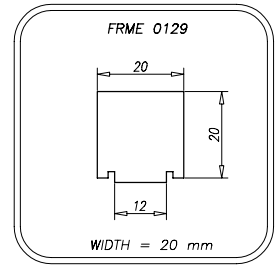
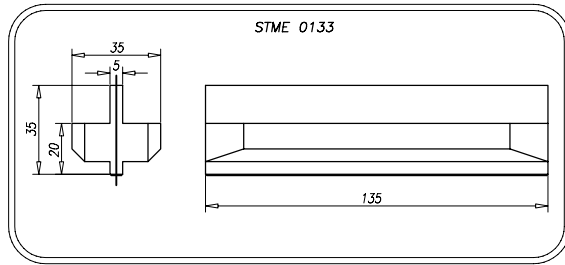

# SPECIAL EXECUTION

## PHOTOS

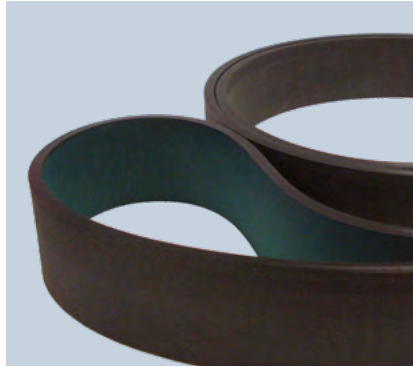

### **AUTOMOTIVE INDUSTRY**

Transport Skids applications for the car industry.

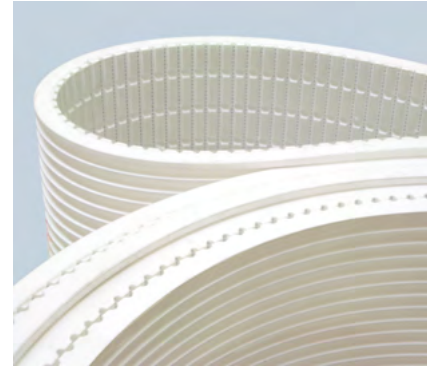

### **MARBLE INDUSTRY**

Custom-made belt with special back grinding for cutting marble blocks.



### **FITNESS INDUSTRY**

Self-tracking belt for treadmill.

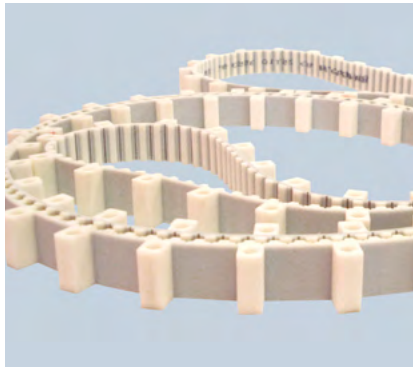

### **TEXTILE INDUSTRY**

High variety of cleats allow MEGAFLEX to work in several fields.



### **FOOD INDUSTRY**

High variety of compounds makes the MEGAFLEX belt suitable for different application.



# SPECIAL EXECUTION

## FEASIBILITY

### **LONGITUDINAL REWORK**

Longitudinal rework along the belt's back is possible on covered and uncovered belts. The profile can be machined precisely for the required function. The measurement is given by the depth on the belt's back. Most widths and lengths are available.

### **REWORK ON BELT TEETH**

The rework of the tooth profile can be very useful, i.e. improving the steering effect with guide rails. The rework dimension is given from the top of the tooth. Most belt widths and lengths are available.

### **HOLES IN TIMING BELTS**

Holes in timing belts can be for vacuum or air film conveying or as clearance for assembly mechanisms. Stops and cams can be attached through the holes. Customized tooling may be required depending on the layout and dimensions of the holes required.

### **SINGLE TOOTH REMOVAL**

Single and multiple tooth removal is available to your requirement, for applications in handling and conveying technology.



## SPECIAL EXECUTION

Megadyne can make special extrusions on customer request to improve the belt's properties and to suit better to special applications.

### **SPECIAL POLYURETHANE**

On customer request and with a minimum quantity, MEGAFLEX belt can be produced with different hardness:

- 90 ShA food quality polyurethane for contact with Food and medical products
- PU blue FCM certified for contact with food
- PU dark blue XMD (Metal and X-ray detectable)
- 92 ShA silicon free for painting system
- 95 ShA glass reinforced
- 98 ShA extra hard polyurethane
- 92 ShA higher resistance to temperature

### **COLOUR**

On customer request and with a minimum quantity, is possible to produce MEGAFLEX with several colours. A different colour doesn't influence the belt's technical properties, thence the mechanical features are the same as the standard white belt.

Available colours are: • White • Black • Blue • Yellow • Transparent • Grey

### **BIFILAR CORDS**

On request, all MEGAFLEX range can be manufactured with bifilar twisting cords.

### **SPECIAL THICKNESS AND BACK GRINDING**

All MEGAFLEX belts back are grinded. Sometimes additional grinding may be required to achieve a precise belt thickness as an adjunction to drive's precision. When belt back grinding tolerance is required, the total thickness, including the tooth, must be specified. A grinding tolerance of  $\pm 0,2$  mm is achievable with a good finish level (i.e. the thickness will not vary greatly around the belt). On request, it is possible to produce MEGAFLEX with extra thickness. Most widths and lengths are available.

# COVER PROPERTIES

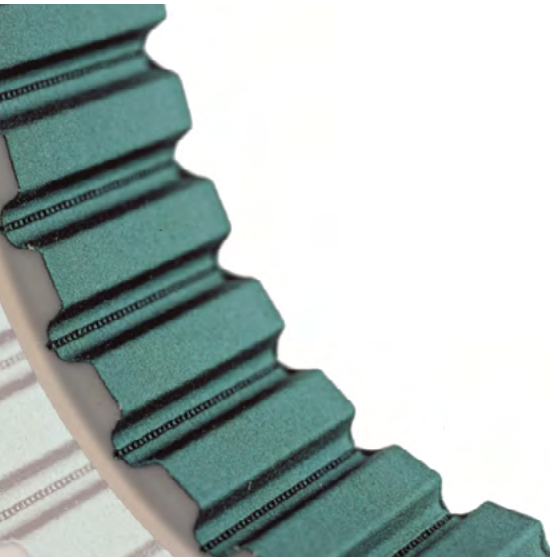

MEGAFLEX belt can be coated with several materials. Those coatings are able to suit MEGAFLEX belts to all applications. The main advantages of using coated belts are the reduction of noise and the modification of the friction in conveying materials. The choice of the correct coating depends on the application field. Megadyne is able to supply extruded coated belts; in this case, the coating method is the same as the belt production method and the cohesion between the belt and the cover is guaranteed by welding without the use of glue.

Contact Megadyne's team for custom solutions.

COVER TYPE									
	NFT/NFB NYLON FA- BRIC TEETH/ BACK	AVAFC 60	AVAFC 70	AVAFC 85	PU YELLOW, GREY, RED	APL	PU FISHBONE	PU RIBBED	RED GRIP
<b>Raw material</b>	nylon	polyurethane	polyurethane	polyurethane	foamed polyurethane	polyurethane/ PVC	polyurethane	polyurethane	PU / synthetic rubber
<b>Hardness (ShA)</b>	–	60	70	85	35-40 50 60-70	55	70	70	63 +/- 4
<b>Colour</b>	green; black (antistatic)	transparent	transparent	transparent	yellow/grey/ red	red	transparent	transparent	red
<b>Coating and belt cohesion method</b>	extrusion lamination	extrusion	extrusion	extrusion	spraying	extrusion	extrusion	extrusion	extrusion
<b>Thickness range (mm)</b>	0,15 - 0,6	2/3/4	2/3/4	2/3/4	1 to 10	3,5	4,3	2,7	1 to 8
<b>Tolerance on coating thickness</b>	–	+ /- 0,3	+/- 0,3	+/- 0,3	+/- 0,3	+/- 0,3	+/- 0,5	+/- 0,5	+/- 0,3
<b>Working temperature range (°C)</b>	-20 +80	-20 +80	-20 +80	-20 +80	-10 +60	-20 +60	-20 +80	-20 +80	- 20 +60
<b>Friction coefficient (1)</b>	0,25	0,65	0,65	0,60	0,40	0,70	0,60	0,60	0,70
<b>Water resistance</b>	good	good	very good	good	fair	good	very good	very good	good
<b>Abrasion resistance</b>	fair	good	good	very good	very good	good	good	good	very good
<b>Oil resistance</b>	fair	good	fair	good	good	good	fair	fair	very good
<b>FDA approved</b>	no	no	no	no	no	no	no	no	no
<b>Min. pulley dia = thickness • ... (2)</b>	std pulley	x 40	x 40	x 40	x 25	x 30	x 30	x 35	x 30

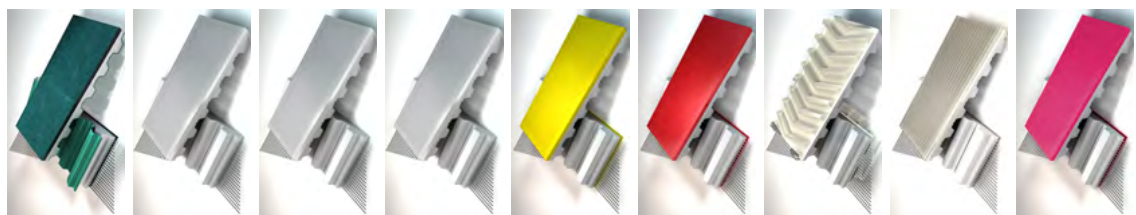

(1) CoF - Determined by the static value against a steel guide; however, consideration must be given to the specific environmental conditions (contamination and/or wear resistance) and aging on the cover.

(2) Pd - Suggested diameter is bigger value between this calculated value and minimum pulley diameter on belt data page.

(\*) with add. grinding +/- 0,3 mm possible.

MEGAFLEX

# COVER PROPERTIES

COVER TYPE										
HONEYCOMB	LINATEX™	RED NATURAL RUBBER 40	DURATAQ®	TENAX STANDARD	GUMMY CORREX AMBRA PARABLOND	BLACK NEOPRENE	NBR	LINAPLUS FG	POROL BLACK	SUPERGRIP PETROL
natural rubber	natural rubber	natural rubber	natural rubber	natural rubber	natural rubber	neoprene	nitrile caoutchouc	natural rubber	natural cellular rubber foam	PVC
50	38 / 40	40	45	45	48	50 70 (VUC)	50 65-70 (VUC)	38	290 kg/m³	46
red	red	red	orange	red	beige	black	black/white	white	black	petrol green
lamination	lamination; vulcanization	vulcanization	vulcanization	vulcanization	vulcanization	lamination; vulcanization	lamination; vulcanization	lamination	lamination	extrusion lamination
4,5 to 15	1 to 10 3 to 12,7 (VUC)	2,4 to 14	2,4 to 14	0,8 to 15	0,8 to 15	3 to 12; 0,8 to 15	2 to 6; 0,8 to 15	1 to 3	2 to 20	4,5
+/- 0,5	+/- 1 (*)	+/- 0,3	+/- 0,3	+/- 0,3	+/- 0,3	+/- 0,3	+/- 0,5 +/- 0,3	+/- 1 (*)	+/- 0,5	+/- 0,5
-20 +60	-40 +70	-20 +80	-20 +100	-20 +60	-20 +60	-20 +60; -10 +100	-35 +70; 0 +120	-40 +70	-40 +70	- 10 +60
0,60	0,90	0,50	1,10	0,70	0,60	0,60	0,70 0,60	0,75	1,20	0,90
very good	good	good	good	very good	very good	good	very good; good	good	very good	good
very good	good	fair	very good	very good	very good	good	poor; good	fair	fair	fair
poor	poor	poor	poor	poor	poor	good	good	poor	fair	good
no	no	no	no	no	no	no	no	yes	no	no
x 30	x 20	x 20	x 20	x 30	x 30	x 30	x 30 x 35	x 25	x 15	60 mm



# MEGAFLEX

The data and information contained in the present catalogue are updated to the date of the catalogue's printing. Ammega Italia S.p.A. reserves the right to modify the specifications, performances and other information relating to the belts described in the present catalogue, at any time at its own discretion, without any prior notice.

For updating refer to our website [www.Megadynegroup.com](http://www.Megadynegroup.com).

Technical specifications, performances and other information provided in the present catalogue are indicative and do not bound Ammega Italia S.p.A. unless such specifications, performances or other information are expressly agreed in the agreement with the customer.

We also recommend to read carefully the following documents on our web site [www.Megadynegroup.com](http://www.Megadynegroup.com):

- Ammega Italia S.p.A. General Conditions of Sale (comprising the warranty)
- Theoretical Belt Life
- Drive Components: Storage, Installation, Maintenance and Troubleshooting Handbook
- Belts standard use condition and temperature.

Copyright Notice: Ammega Italia S.p.A. copyright. All rights reserved.

Ammega Italia S.p.A. is and shall remain the owner of all rights on drawings, technical specifications and any other information contained in the present catalogue or otherwise communicated by Ammega Italia S.p.A. to the customer.

The customer shall not disclose such information to third parties or use such information for purposes different from the definition of the order to Ammega Italia S.p.A., unless upon prior written authorization of Ammega Italia S.p.A.



Ammega Italia S.p.A.  
ITALY - MATHI

# Discover Your Local Contacts

The local partner of choice  
for sustainable power transmission belting solutions  
around the globe.



**General contact information:**

**Megadyne**

Via Trieste, 16  
Via S. Lucia 114 - 10075 Mathi (Torino)  
Italy



Scan the QR code  
and find your local  
contact

