

ENGINEERED BELTS “MTS”

EN

PRODUCT
BROCHURE

WE ARE **MEGADYNE**

Megadyne manufactures a full line of power transmission belting solutions for industrial distribution and original equipment manufacturers (OEMs). We are a GLOBAL LEADER in rubber and polyurethane synchronous belts, engineered belts and V-belts with manufacturing plants in Europe, North America, and Asia.
We Make Your Business Move!



OUR SOLUTIONS

Our customers are original equipment manufacturers and aftermarket distributors, for whom we deliver a large range of products. Our offering includes thermoset and thermoplastic polyurethane belts, rubber timing and V-belts, flat belts, multi-rib belts, specialty belts, pulleys, clamping plates, timing bars and complementary products, including custom-made. Megadyne can fully customize the belts with special cover and/or machined modifications to meet any specific customer's requirement: holes, perforations, slots, teeth removal, vacuum countersink, V-guides



ENGINEERED BELTS ARE NOW AVAILABLE IN STOCK!

That means **reduced lead times**: our **NEW STOCK LINEUP** can be quickly picked, packed, and shipped as soon as an order is received.

Customers can receive their special belts in a **matter of days**, rather than having to wait for production to take place.

Quick delivery allows customers a fast restocking to face downtime on peak seasonal demand, minimizing the risks and being well-prepared.

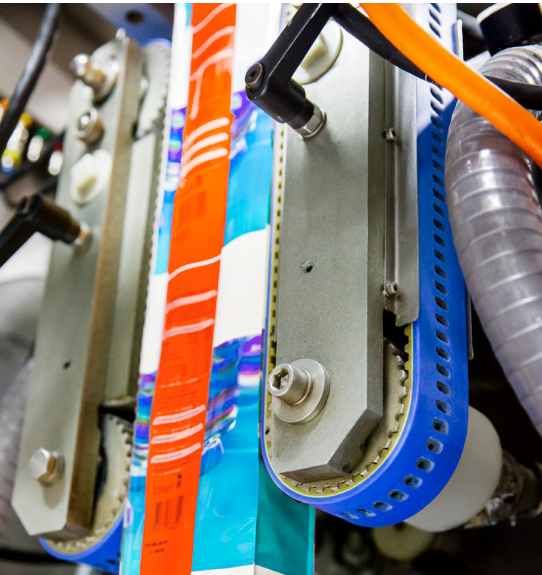

INDUSTRY APPLICATIONS

VFFS

“Pull Down” synchronous belts are used in form fill and seal machines, bagging machines, and vertical scales for various products from the food, chemicals, and other industries. Products that are packaged are often sweets, potato chips, tea, coffee, cookies or pasta. In most cases, there are two belts located opposite each other over a tube (an equal thickness in the entire coating area is ensured by precise manufacturing). Between the tube and the belt, a plastic wrap, paper or foil, is placed on a metal tube to form a bag, which is then filled and sealed.

The toothed belts often have a counterbore or are provided with longitudinal grooves on the coating side in order to be able to suction and guide the packaging with a vacuum.

The advantage of the toothed belt is that it can be driven with the same synchronous speed on both sides of the packaging guide.

Our NEW STOCK LINEUP has the common sizes of VFFS belts supporting most OEM's.

FEATURES & BENEFITS

- Toothed belt that can be driven with the same synchronous speed on both sides of the packaging guide
- Homogeneous molded covers to provide uniform wear surfaces free of hard spots to increase performance
- Continuous durable wearing covers to provide consistent friction for extended life of the belt
- CNC equipment used to machine holes, slots, grooves, and profiles within precise tolerances for outlasting performance
- Covers without any splices or seams for increased reliability
- Excellent abrasion resistance for an increased trouble-free lifespan
- Excellent flexibility without cracking or tearing

OTHER MARKET SEGMENTS AND RELATED BELTING SOLUTIONS



Corrugated board Folder gluer belts:

- Feeder/ Ultrafeed belts (sleeves & finished)
- Corrugated belts, various others
- Masterflex belt
- Top & seam compression belt



Packaging

- Pull down belts (sleeves and finished)
- Horizontal flow packer
- Labeling belts
- Cookie belts



Cable

- Cable pulling belts



Textile

- Textile belts

TECHNICAL DATA

ITEM	DESCRIPTION		LENGHT (mm)	WIDHT (mm)	TOTAL THICKNESS (MM)	INDUSTRY APPLICATION	PAGE
019000020065	TIMING BELT 32-AT10 840 NT MV+3.0 MM NRS040 RED+ PERF+FAST MTS	●	840	32	7,5	Corrugated Masterflex belts	6
010430560958	MEGASYNC RPP BELT 800 RPP8 25 HT BACK SILICONE (BLUE) TT. 7,8 MM. (SET OF 2) MTS	●	800	25	7,8	Corrugated belts	6
010430560959	MEGASYNC RPP BELT 880 RPP8 25 HT BACK SILICONE (BLUE) TT. 7,8 MM. (SET OF 2) MTS	●	880	25	7,8	Corrugated belts	6
010430560960	MEGASYNC RPP BELT 1040 RPP8 25 HT BACK SILICONE (BLUE) TT. 7,8 MM. (SET OF 2) MTS	●	1040	25	7,8	Corrugated belts	6
010430560961	MEGASYNC RPP BELT 1280 RPP8 25 HT BACK SILICONE (BLUE) TT. 7,8 MM. (SET OF 2) MTS	●	1280	25	7,8	Corrugated belts	6
010430560962	MEGASYNC RPP BELT 1440 RPP8 25 HT BACK SILICONE (BLUE) TT. 7,8 MM. (SET OF 2) MTS	●	1440	25	7,8	Corrugated belts	6
010430560963	MEGASYNC RPP BELT 1800 RPP8 25 HT BACK SILICONE (BLUE) TT. 7,8 MM. (SET OF 2) MTS	●	1800	25	7,8	Corrugated belts	6
010430560964	MEGASYNC RPP BELT 2400 RPP8 25 HT BACK SILICONE (BLUE) TT. 7,8 MM. (SET OF 2) MTS	●	2400	25	7,8	Corrugated belts	6
010430560965	MEGASYNC RPP BELT 3048 RPP8 25 HT BACK SILICONE (BLUE) TT. 7,8 MM. (SET OF 2) MTS	●	3048	25	7,8	Corrugated belts	6
010430560967	MEGASYNC RPP BELT 800 RPP8 25 HT BACK SILICONE (BLUE) TT. 7,8 MM. (SET OF 3) MTS	●	800	25	7,8	Corrugated belts	6
010430560966	MEGASYNC RPP BELT 880 RPP8 25 HT BACK SILICONE (BLUE) TT. 7,8 MM. (SET OF 3) MTS	●	880	25	7,8	Corrugated belts	6
010430560968	MEGASYNC RPP BELT 1040 RPP8 25 HT BACK SILICONE (BLUE) TT. 7,8 MM. (SET OF 3) MTS	●	1040	25	7,8	Corrugated belts	6
010430560969	MEGASYNC RPP BELT 1280 RPP8 25 HT BACK SILICONE (BLUE) TT. 7,8 MM. (SET OF 3) MTS	●	1280	25	7,8	Corrugated belts	6
010430560970	MEGASYNC RPP BELT 1440 RPP8 25 HT BACK SILICONE (BLUE) TT. 7,8 MM. (SET OF 3) MTS	●	1440	25	7,8	Corrugated belts	6
010430560971	MEGASYNC RPP BELT 1800 RPP8 25 HT BACK SILICONE (BLUE) TT. 7,8 MM. (SET OF 3) MTS	●	1800	25	7,8	Corrugated belts	6
010430560972	MEGASYNC RPP BELT 2400 RPP8 25 HT BACK SILICONE (BLUE) TT. 7,8 MM. (SET OF 3) MTS	●	2400	25	7,8	Corrugated belts	6
010430560973	MEGASYNC RPP BELT 3048 RPP8 25 HT BACK SILICONE (BLUE) TT. 7,8 MM. (SET OF 3) MTS	●	3048	25	7,8	Corrugated belts	6
019000020066	TIMING BELT RPP5+NRS040 RED 535x35X6.85 MTS	●	535	35	6,85	Feeder belts	6
019000020068	TIMING BELT RPP5+NRS040 RED 755x35X6.85 MTS	●	755	35	6,85	Feeder belts	7
019000020067	TIMING BELT RPP5+NRS040 RED PERF 535x35X6.85 MTS	●	535	35	6,85	Feeder belts	7
019000020069	TIMING BELT RPP5+NRS040 RED PERF 755x35X6.85 MTS	●	755	35	6,85	Feeder belts	7
019000020070	TIMING BELT RU 50T10 630+EPC035-G10 RED T1 X9.0 MTS	●	630	50	9	Pull down belts	8
019000020075	TIMING BELT RU 50T10 780+EPC035-G10 RED T1 X9.0 MTS	●	780	50	9	Pull down belts	8
019000020071	TIMING BELT RU 50T10 630+EPC035-G10 RED T2 X9.0 MTS	●	630	50	9	Pull down belts	8
019000020072	TIMING BELT RU 30T10 630+EPC035-G10 RED T3 X9.0 MTS	●	630	30	9	Pull down belts	9
019000020076	TIMING BELT RU 30T10 780+EPC035-G10 RED T3 X9.0 MTS	●	780	30	9	Pull down belts	9

TECHNICAL DATA

ITEM	DESCRIPTION		LENGHT (mm)	WIDHT (mm)	TOTAL THICKNESS (mm)	INDUSTRY APPLICATION	PAGE
019000020073	TIMING BELT RU 29T10 630+EPC035-G10 RED T4 X10.9 MTS	●	630	29	10,9	Pull down belts	9
019000020074	TIMING BELT RU 50T10 630+EPC035-G10 RED T5 X10.9 MTS	●	630	50	10,9	Pull down belts	10
019006990001	TIMING BELT RU 50T10 630+EPC035-G10 RED T6 X10.9 MTS	●	630	50	10,9	Pull down belts	10
0479000007012	255H150 NATURAL RUBBER RED 40 SHA 7 MM OAG - NG-MR-P1	○	647,7	38,1	7	VAC Pull down belts	10
010011900750	MEGAPOWER BELT 50 T10 VACUUM 920 KEVLAR CORD FOAMED PU (YELLOW) 60 SHA 3 MM. MTS	●	920	50	7,5	VAC Pull down belts	11
010011900751	MEGAPOWER BELT 50 T10 VACUUM 920 KEVLAR CORD FOAMED PU (YELLOW) 60 SHA 3 MM. MTS	●	920	50	7,5	VAC Pull down belts	11
010011900752	MEGAPOWER BELT 30 T10 VACUUM 920 KEVLAR CORD FOAMED PU (YELLOW) 60 SHA 3 MM. MTS	●	920	30	7,5	VAC Pull down belts	11
010011900753	MEGAPOWER BELT 30 T10 VACUUM 920 KEVLAR CORD FOAMED PU (YELLOW) 60 SHA 3 MM. MTS	●	920	30	7,5	VAC Pull down belts	11
010011900754	MEGAPOWER BELT 50 T10 VACUUM 920 KEVLAR CORD FOAMED PU (YELLOW) 60 SHA 3 MM. MTS	●	920	50	7,5	VAC Pull down belts	11
010011900755	MEGAPOWER BELT 37 T10 VACUUM 920 KEVLAR CORD FOAMED PU (YELLOW) 60 SHA 3 MM. MTS	●	920	37	7,5	VAC Pull down belts	12
010011900756	MEGAPOWER BELT 50 T10 VACUUM 800 KEVLAR CORD TENAX (RED) 45 SHA 6 MM. MTS	●	800	50	10,5	VAC Pull down belts	12
010011900757	MEGAPOWER BELT 50 T10 VACUUM 800 KEVLAR CORD TENAX (RED) 45 SHA 6 MM. MTS	●	800	50	10,5	VAC Pull down belts	12
010011900758	MEGAPOWER BELT 50 T10 VACUUM 800 KEVLAR CORD TENAX (RED) 45 SHA 6 MM. MTS	●	800	50	10,5	VAC Pull down belts	12
010010196219	MEGAPOWER BELT 25 T10 440 STEEL CORD TENAX (RED) 45 SHA 8 MM. MTS	●	440	25	12,5	VAC Pull down belts	13
010420051316	MEGASYNC BELT 270 L 100 TENAX (RED) 45 SHA 8 MM. MTS	●	685,8	25,4	12,5	VAC Pull down belts	13
010010196221	MEGAPOWER BELT 25 T10 560 STEEL CORD TENAX (RED) 45 SHA 8 MM. MTS	●	560	25	12,5	VAC Pull down belts	13
01001017A644	MEGAPOWER BELT 16 T5 455 STEEL CORD PU (TRANSPARENT) 70 SHA 2 MM. MTS	○	455	16	4,2	Cable Puller Belts	14
01001017A645	MEGAPOWER BELT 16 T5 455 STEEL CORD FOAMED PU (YELLOW) 70 SHA 2 MM. MTS	●	455	16	4,2	Cable Puller Belts	14
010010196224	MEGAPOWER BELT 26 T10 3040 STEEL CORD CLEATS (DRAWING) MTS		3040	26		Textile belts	14
010010196225	MEGAPOWER BELT 26 T10 3040 STEEL CORD CLEATS (DRAWING) MTS		3040	26		Textile belts	15
010040199307	JOINED BELT 75 T10 3210 STEEL CORD MTS		3210	75		Hygiene toilet paper belts	15
010040252597	JOINED BELT 10 AT5 1505 STEEL CORD NFT+CLEATS (DRAWING) MTS		1505	10		Horizontal flow packer belts	15
010040252598	JOINED BELT 10 AT5 1700 STEEL CORD NFT+CLEATS (DRAWING) MTS		1700	10		Horizontal flow packer belts	15
010020256304	MEGAFLEX BELT 10 AT5 1700 STEEL CORD NFT+CLEATS (DRAWING) MTS		1700	10		Horizontal flow packer belts	15
010040252599	JOINED BELT 10 AT5 2000 STEEL CORD NFT+CLEATS (DRAWING) MTS		2000	10		Horizontal flow packer belts	15

Note: Belts will be produced unbranded

ENGINEERED BELTS
MTS

TECHNICAL DRAWINGS

019000020065

32-AT10 840 NT MV+3.0 MM NRS040 RED + PERF + FAST

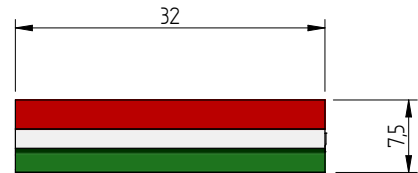
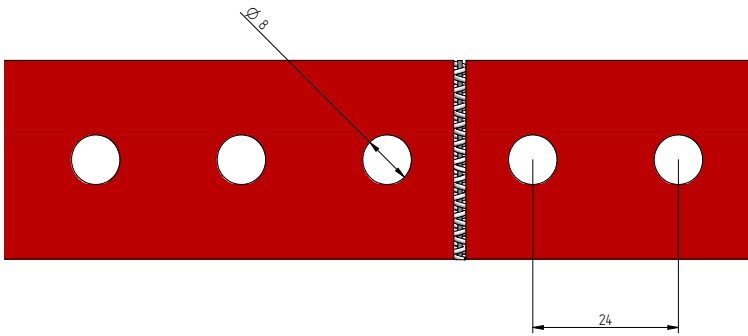

From 010430560958 to 010430560973

MEGASYNC RPP8 25 HT BACK SILICONE (various lengths, in set of 2 or 3)

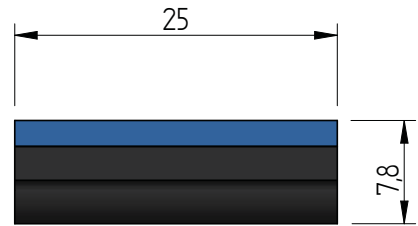

019000020066

TIMING BELT RPP5 + NRS040 RED 535x35X6.85

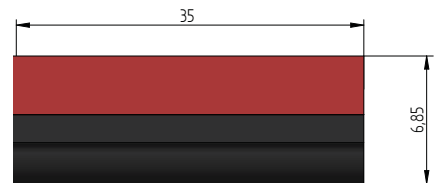

TECHNICAL DRAWINGS

019000020068
TIMING BELT RPP5 + NRS040 RED 755x35X6.85

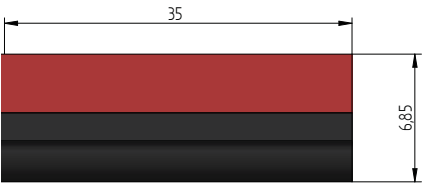

0109000020067
TIMING BELT RPP5 + NRS040 RED 535x35X6.85 + PERF

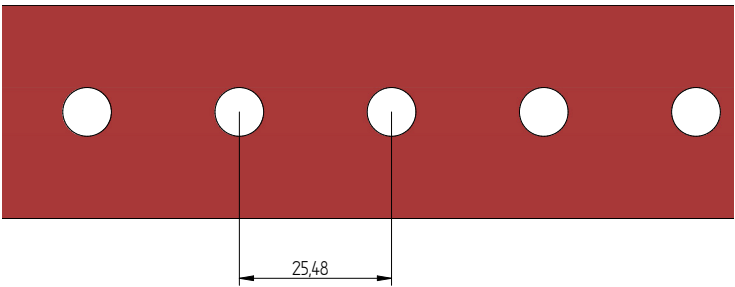
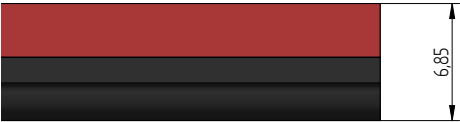

019000020069
TIMING BELT RPP5 + NRS040 RED 755x35X6.85 + PERF

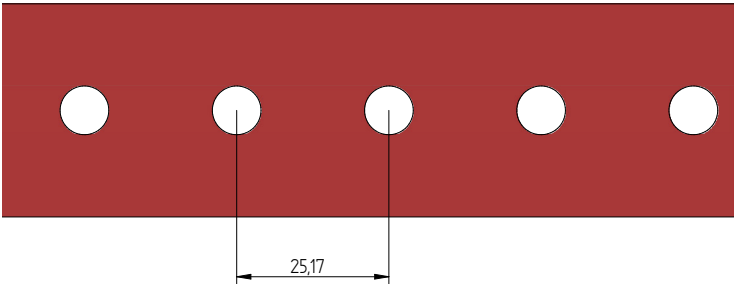
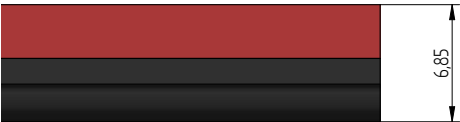

Note: Drawings could be out of scale

ENGINEERED BELTS
MTS

TECHNICAL DRAWINGS

019000020070
TIMING BELT RU 50T10 630 + EPC035-G10 RED T1 X9.0

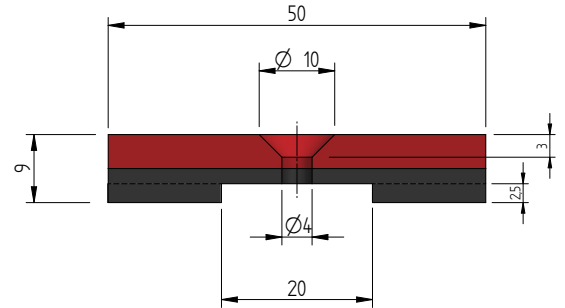
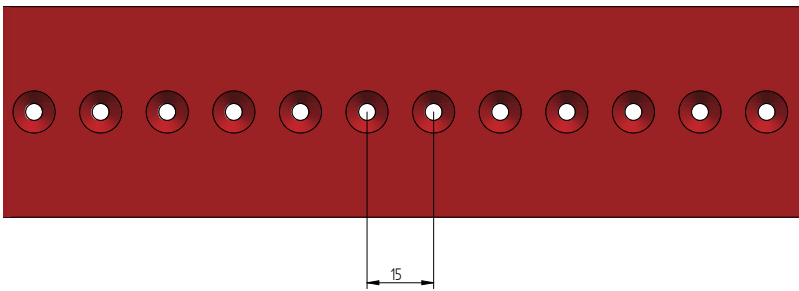

019000020075
TIMING BELT RU 50T10 780 + EPC035-G10 RED T1 X9.0

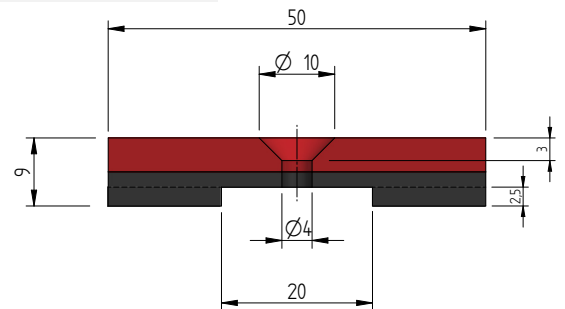
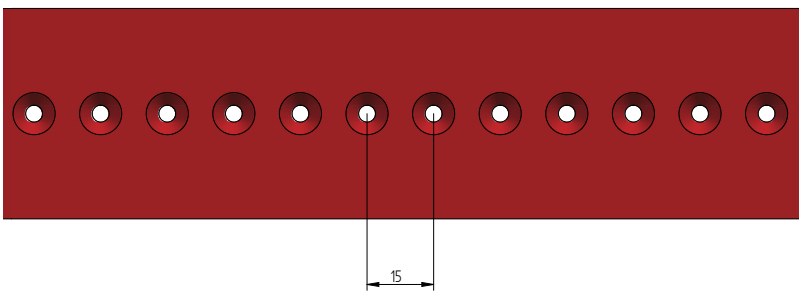

019000020071
TIMING BELT RU 50T10 630 + EPC035-G10 RED T2 X9

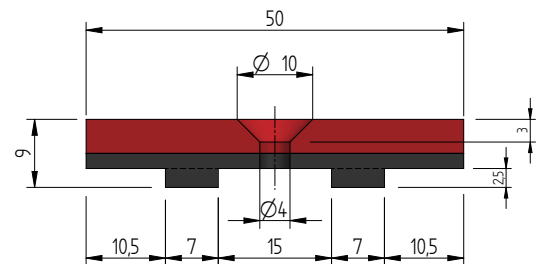
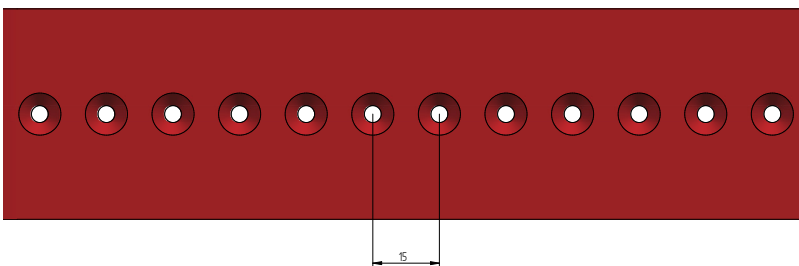

TECHNICAL DRAWINGS

019000020072
TIMING BELT RU 30T10 630 + EPC035-G10 RED T3 X9.0

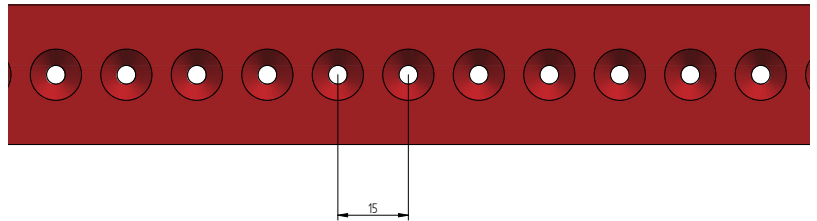
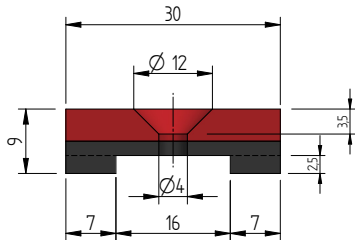

019000020076
TIMING BELT RU 30T10 780 + EPC035-G10 RED T3 X9.0

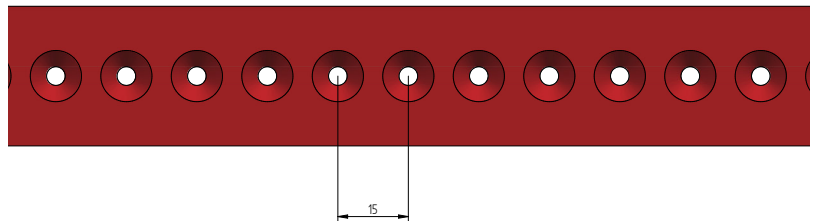
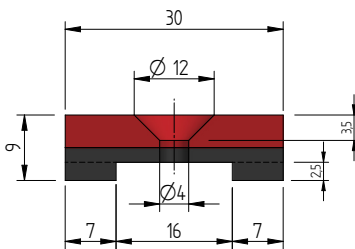

019000020073
TIMING BELT RU 29T10 630 + EPC035-G10 RED T4 X10.9

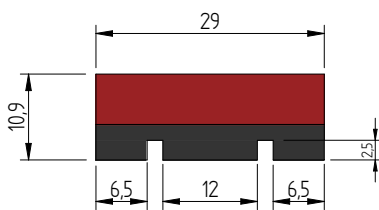

Note: Drawings could be out of scale

ENGINEERED BELTS
MTS

TECHNICAL DRAWINGS

019000020074

TIMING BELT RU 50T10 630 + EPC035-G10 RED T5 X10.9

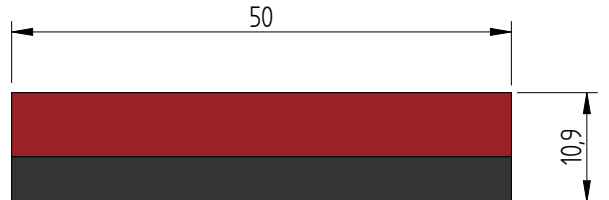

019006990001

TIMING BELT RU 50T10 630 + EPC035-G10 RED T6 X10.9

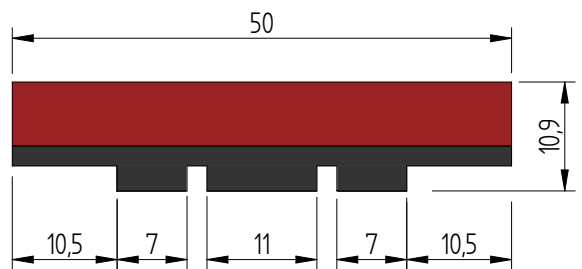

TECHNICAL DRAWINGS

010011900750 | 010011900751
MEGAPOWER BELT 50 T10 VACUUM 920 KEVLAR CORD FOAMED PU 60 SHA 3 MM

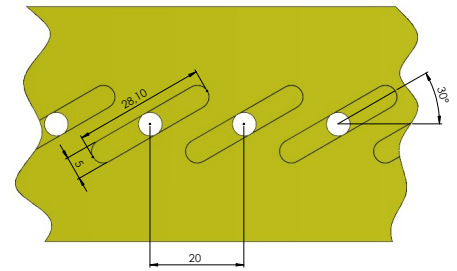
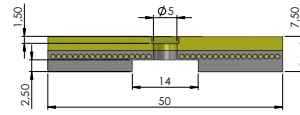
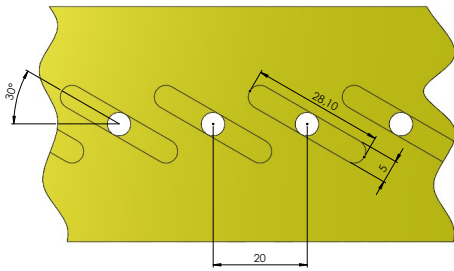

010011900752 | 010011900753
MEGAPOWER BELT 30 T10 VACUUM 920 KEVLAR CORD FOAMED PU 60 SHA 3 MM

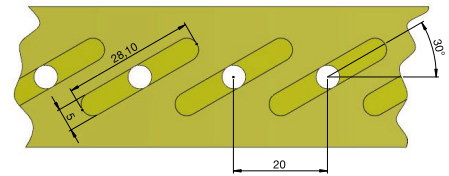
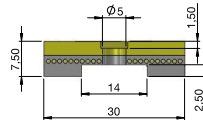
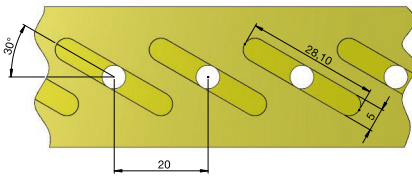

010011900754
MEGAPOWER BELT 50 T10 VACUUM 920 KEVLAR CORD FOAMED PU 60 SHA 3 MM

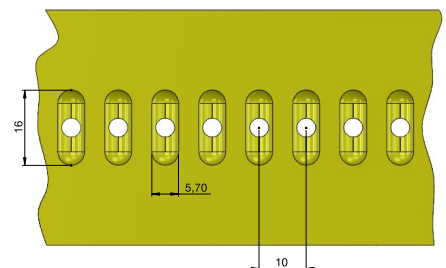
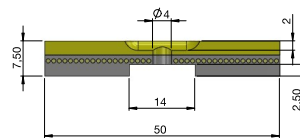

Note: Drawings could be out of scale

ENGINEERED BELTS
MTS

TECHNICAL DRAWINGS

010011900755

MEGAPOWER BELT 37 T10 VACUUM 920 KEVLAR CORD FOAMED PU 60 SHA 3 MM

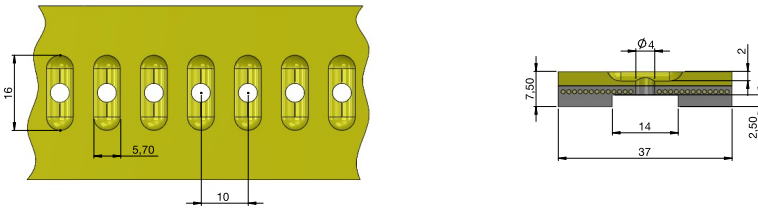

010011900756

MEGAPOWER BELT 50 T10 VACUUM 800 KEVLAR CORD TENAX 45 SHA 6 MM

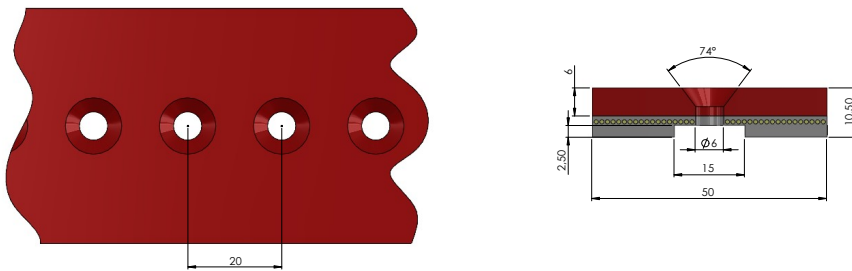

010011900757 | 010011900758

MEGAPOWER BELT 50 T10 VACUUM 800 KEVLAR CORD TENAX 45 SHA 6 MM

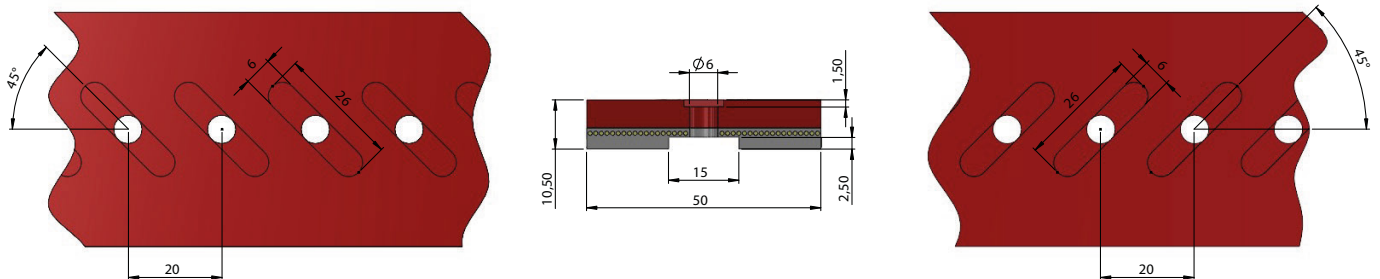

ENGINEERED BELTS
MTS

Note: Drawings could be out of scale

TECHNICAL DRAWINGS

010010196219
MEGAPOWER BELT 25 T10 440 STEEL CORD TENAX 45 SHA 8 MM

Tenax Red Cover 45 ShA

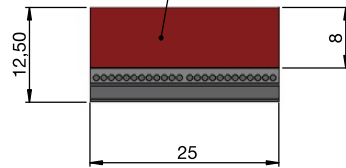

010420051316
MEGASYNC BELT 270 L 100 TENAX 45 SHA 8 MM

Tenax Red Cover 45 ShA

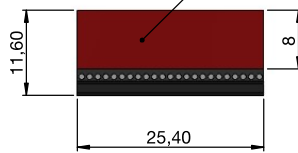

010010196221
MEGAPOWER BELT 25 T10 560 STEEL CORD TENAX 45 SHA 8 MM

Tenax Red Cover 45 ShA

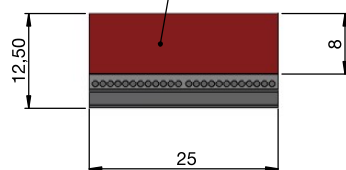

Note: Drawings could be out of scale

ENGINEERED BELTS
MTS

TECHNICAL DRAWINGS

01001017A644
MEGAPOWER BELT 16 T5 455 STEEL CORD PU 70 SHA 2 MM

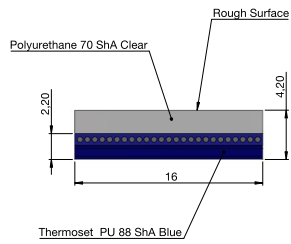

01001017A645
MEGAPOWER BELT 16 T5 455 STEEL CORD FOAMED PU 70 SHA 2 MM

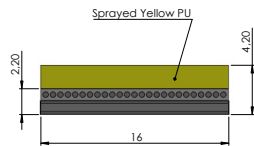

010010196224
MEGAPOWER BELT 26 T10 3040 STEEL CORD + CLEATS

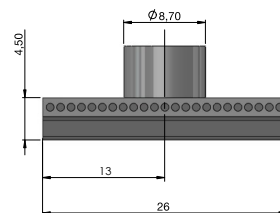
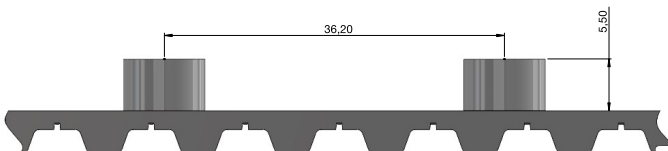

ENGINEERED BELTS
MTS

Note: Drawings could be out of scale

TECHNICAL DRAWINGS

010010196225
MEGAPOWER BELT 26 T10 3040 STEEL CORD + CLEATS

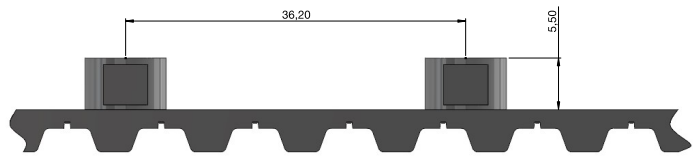
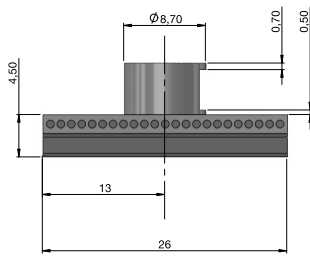

010040199307
JOINED BELT 75 T10 3210 STEEL CORD

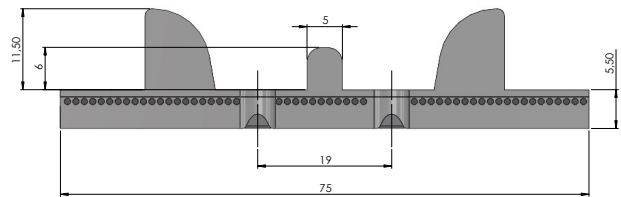

From 010040252597 to 010040252599; 010020256304
JOINED and MEGAFLEX BELTS 10 AT5 STEEL CORD NFT + CLEATS

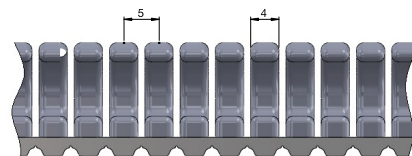
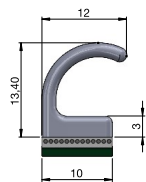

Note: Drawings could be out of scale

ENGINEERED BELTS
MTS

Discover Your Local Contacts

The local partner of choice
for sustainable power transmission belting solutions
around the globe.



General contact information:

Megadyne
Via Trieste, 16
Via S. Lucia 114 - 10075 Mathi (Torino)
Italy



Scan the QR code
and find your local
contact

